

Choose the language

English

Italiano

Français

Deutsch

Blio / Blio Solo

Finish:

Mdf with white Ral 9010 lacquer

Finish for shoe rack shelves:

Beige lacquered steel

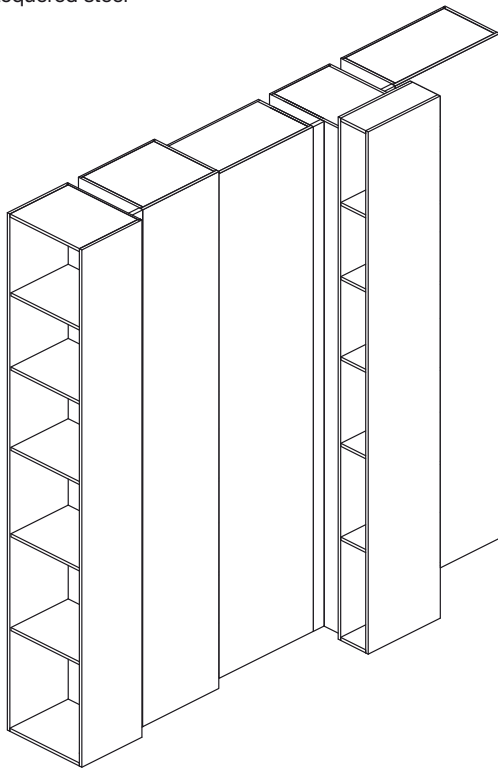

Blio (modular)

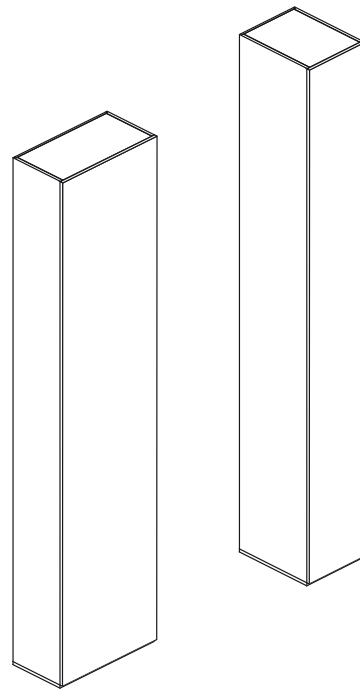

Blio Solo (separate elements)

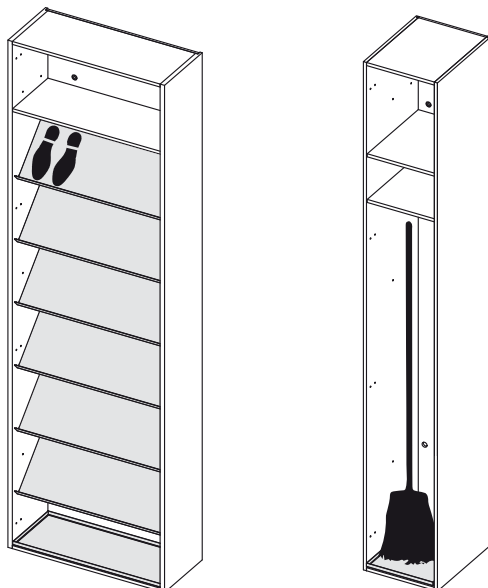

Doors with push-pull opening, 12mm thick.
Shelves are fixed (except for the shoe rack unit).
Non-standard elements cannot be made.
Units must be fastened to the wall.

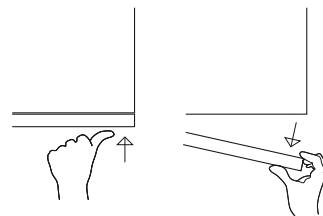

New units with “shoe rack” and “broom rack” accessories

Blio / Blio Solo

Functional use of spaces:

Blio storage units are adapted to house not only books but also everything that may be required in a home environment thanks to compartments in different heights.

Interior spaces are shown as follows:

Shelves are fixed (except for the shoe rack unit).

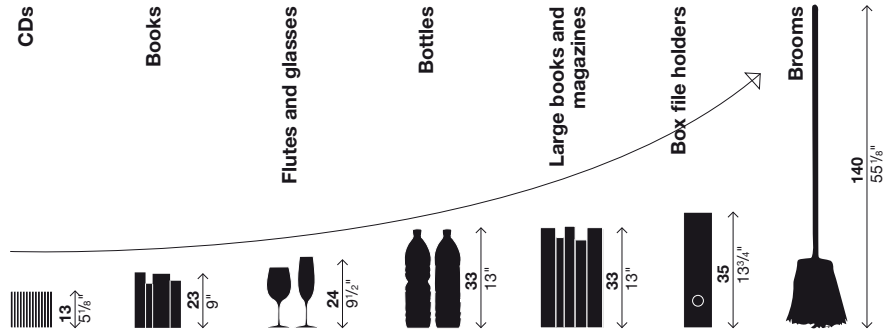

1

15,5
 $\frac{6}{16}$ "

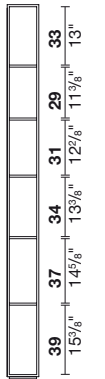

Prof. 40 cm
Depth 15 $\frac{3}{4}$ "

3

35,5 cm
14"

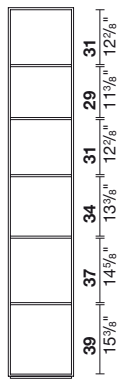

Prof. 29,5 cm
Depth 11 $\frac{5}{8}$ "

4

49,5 cm
19 $\frac{1}{2}$ "

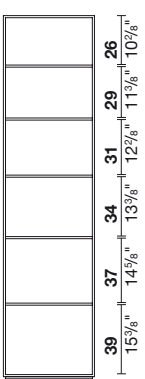

Prof. 24,5 cm
Depth 9 $\frac{3}{4}$ "

5

12,5
 $\frac{5}{16}$ "

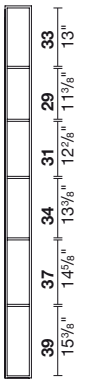

Prof. 36 cm
Depth 14 $\frac{1}{8}$ "

6

34,5 cm
13 $\frac{5}{8}$ "

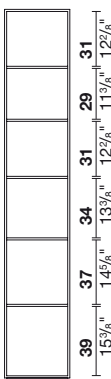

Prof. 28,5 cm
Depth 11 $\frac{2}{8}$ "

7

27,5
10 $\frac{7}{8}$ "

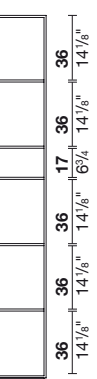

Prof. 36 cm
Depth 14 $\frac{1}{8}$ "

10

60 cm
23 $\frac{3}{4}$ "

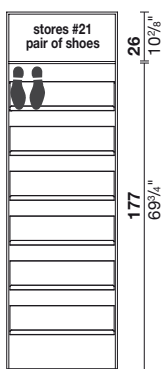

For unit 10 (shoe rack), shelves can be positioned oblique or flat.

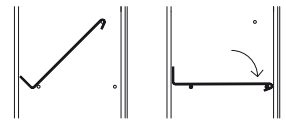

Prof. 24,5 cm
Depth 9 $\frac{3}{4}$ "

11

27,5
10 $\frac{7}{8}$ "

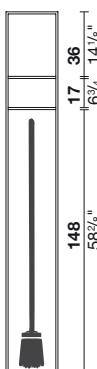

Prof. 36 cm
Depth 14 $\frac{1}{8}$ "

Blio Solo

Unit 3

Independent element.

3

Code		Price in EURO	Packs	Vol. ³	Kg
55BLI3D	R		2	0,35	37,5
55BLI3S	L		2	0,35	37,5

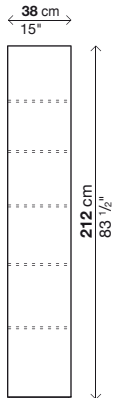
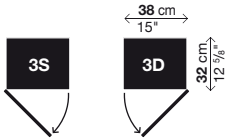
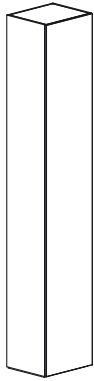

Unit 4

Independent element.

4

Code		Price in EURO	Packs	Vol. ³	Kg
55BLI4D	R		2	0,4	41
55BLI4S	L		2	0,4	41

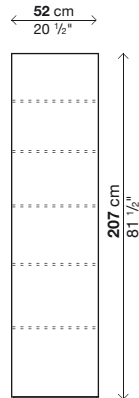
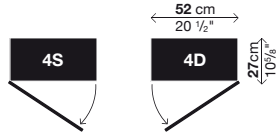

Unit 7

Independent element.

7

Code		Price in EURO	Packs	Vol. ³	Kg
55BLI7D	R		2	0,32	37
55BLI7S	L		2	0,32	37

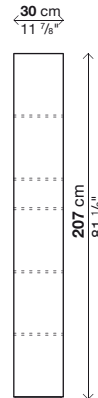
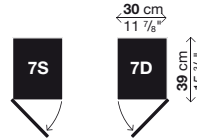
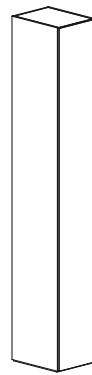

Unit 10

Independent element.

10

Code		Price in EURO	Packs	Vol. ³	Kg
55BLI10D	R		3	0,52	60
55BLI10S	L		3	0,52	60

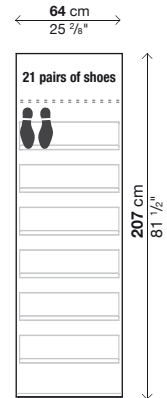
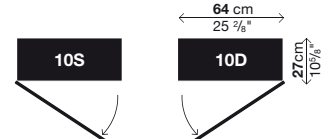

Blio Solo

Unit 11

Independent element.

11

Code	Price in EURO	Packs	Vol. ³	Kg
55BLI11D	R	2	0,32	35
55BLI11S	L	2	0,32	35

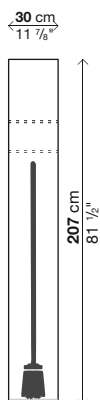
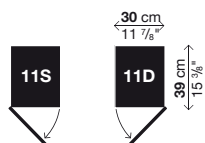

Blio Modular

Unit A

Independent or adjoining unit.

A

Code	Price in EURO	Packs	Vol. ³	Kg
55BLIA1		4	0,76	71

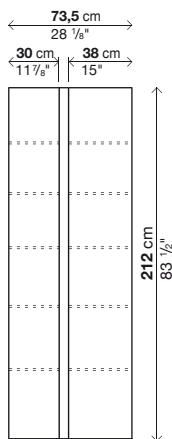
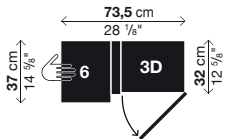
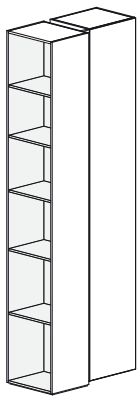

Unit B

Independent or adjoining unit.

B

Code	Price in EURO	Packs	Vol. ³	Kg
55BLIB1		5	1,01	95

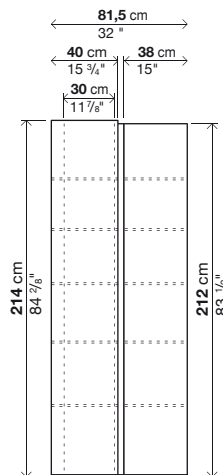
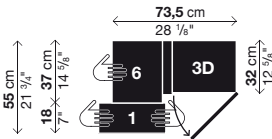
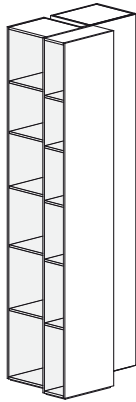

Unit C

Independent or adjoining unit.

C

Code	Price in EURO	Packs	Vol. ³	Kg
55BLIC1		4	0,78	82

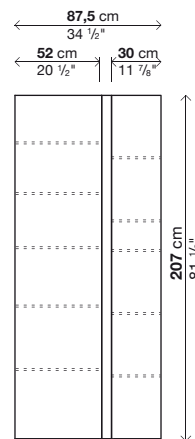
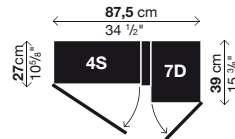
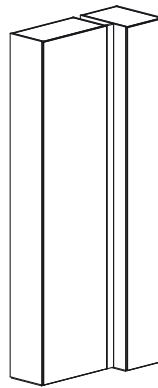

Unit D

Adjoining unit.
Another unit must always be aligned on the right.

D

Code	Price in EURO	Packs	Vol. ³	Kg
55BLID1		3	1	98

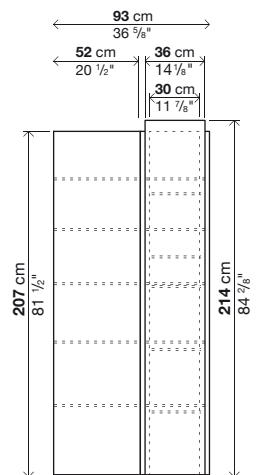
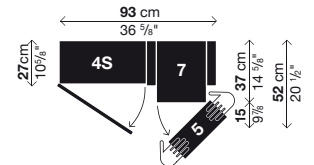
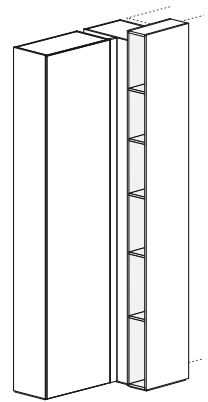

Blio Modular

Unit E

Independent or adjoining unit.

E

Code	Price in EURO	Packs	Vol. ³	Kg
55BLIE1		4	0,8	83

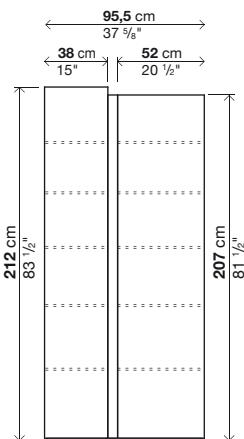
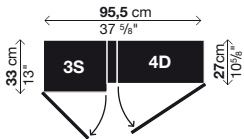
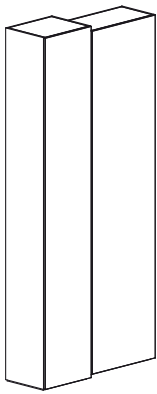

Unit F

Independent or adjoining unit.

F

Code	Price in EURO	Packs	Vol. ³	Kg
55BLIF1		4	0,81	75

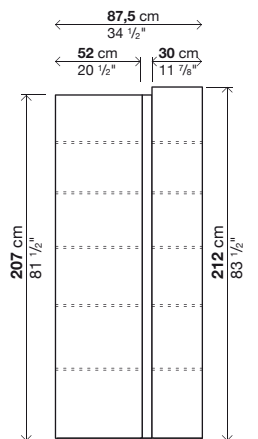
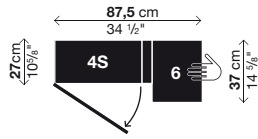
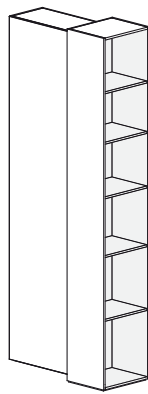

Unit G

Independent or adjoining unit.

G

Code	Price in EURO	Packs	Vol. ³	Kg
55BLIG1		5	1,06	99

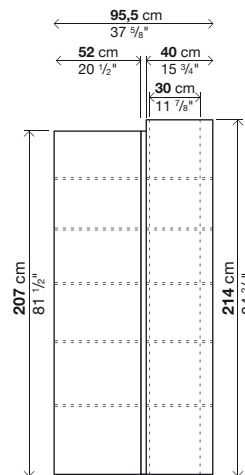
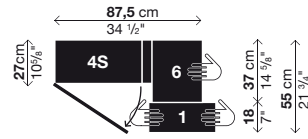
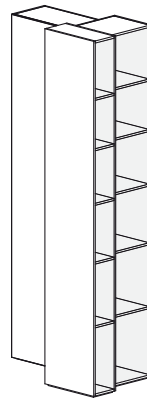

Blio accessories

Modular

Unit L

Independent or adjoining unit.

L

Code	Price in EURO	Packs	Vol. ³	Kg
55BLIL1		5	0,9	101

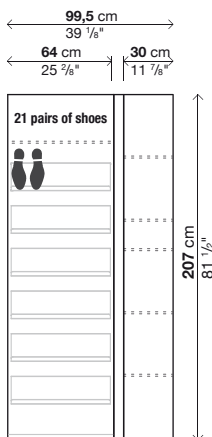
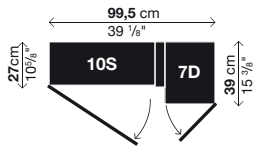
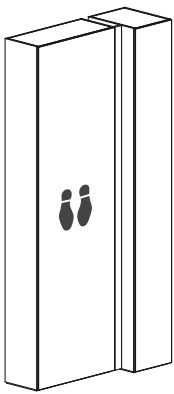

Unit M

Adjoining unit.
Another unit must always be aligned on the right.

M

Code	Price in EURO	Packs	Vol. ³	Kg
55BLIM1		4	1,1	118

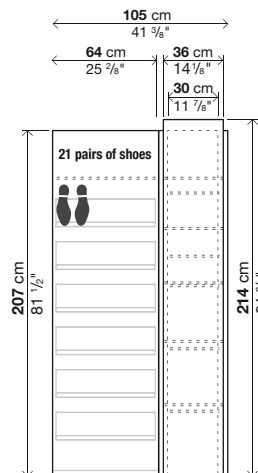
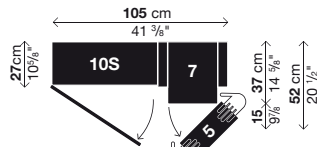
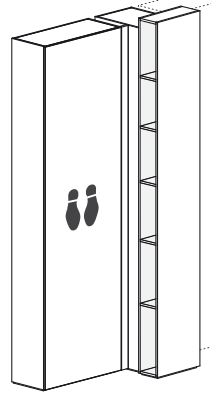

Unit N

Independent or adjoining unit.

N

Code	Price in EURO	Packs	Vol. ³	Kg
55BLIN1		5	0,93	102

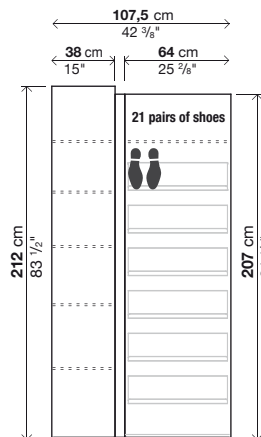
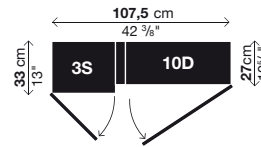
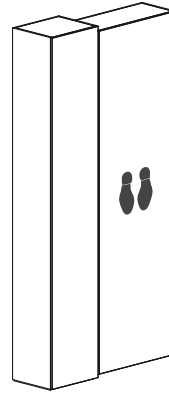

Unit O

Independent or adjoining unit.

O

Code	Price in EURO	Packs	Vol. ³	Kg
55BLIO1		5	0,93	94

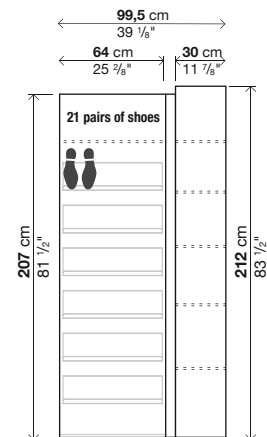
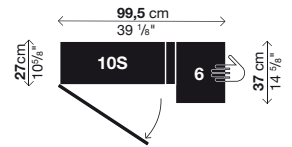
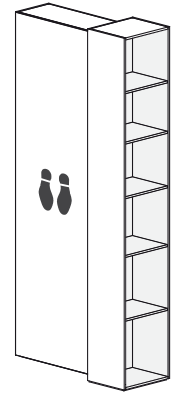

Blio accessories

Modular

Unit P

Independent or adjoining unit.

P

Code	Price in EURO	Packs	Vol. ³	Kg
55BLIP1		6	1,2	118

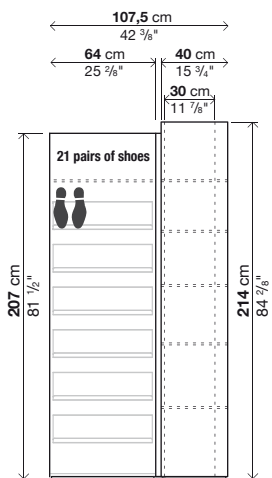
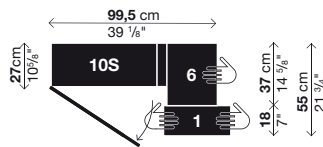
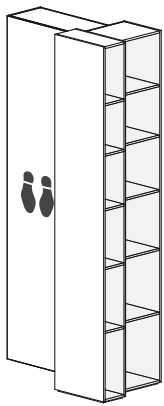

Unit R

Independent or adjoining unit.

R

Code	Price in EURO	Packs	Vol. ³	Kg
55BLIR1		5	0,78	80

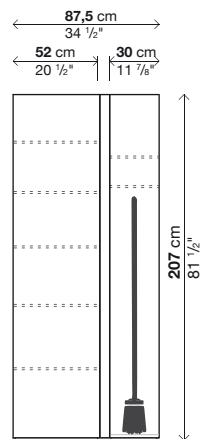
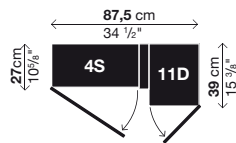
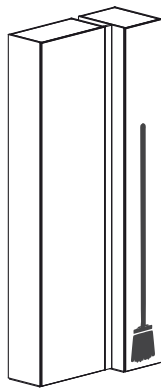

Unit S

Independent or adjoining unit.

S

Code	Price in EURO	Packs	Vol. ³	Kg
55BLIS1		5	0,9	100

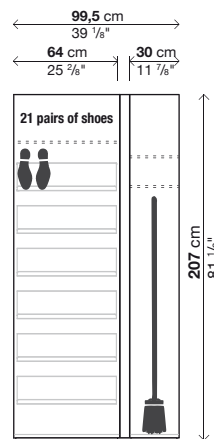
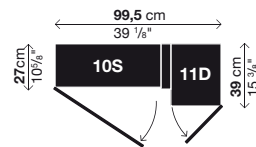
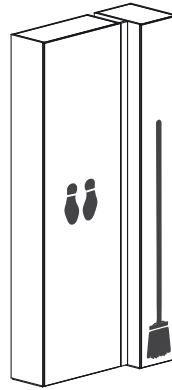

Blio

Example layouts

Composition B1
Unit C + Unit E

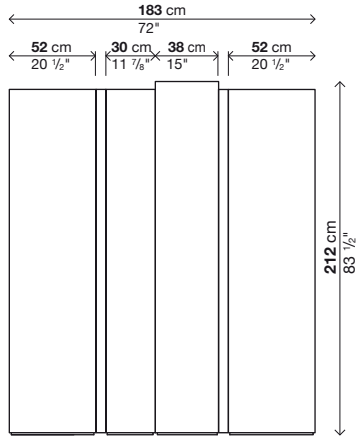
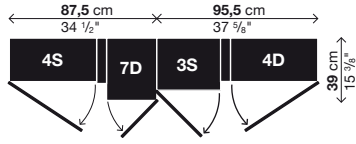

Code	Price in EURO	Packs	Vol. 3	Kg
55BLIC1 + 55BLIE1		8	1,6	165

Composition B2
Unit A + Unit F

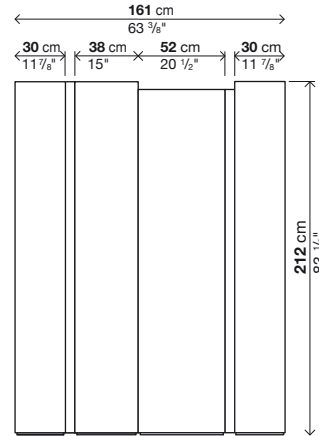
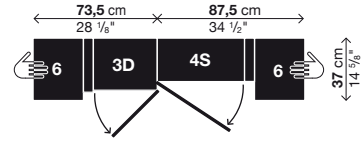

Code	Price in EURO	Packs	Vol. 3	Kg
55BLIA1 + 55BLIF1		8	1,6	146

Composition B3
Unit D + Unit F

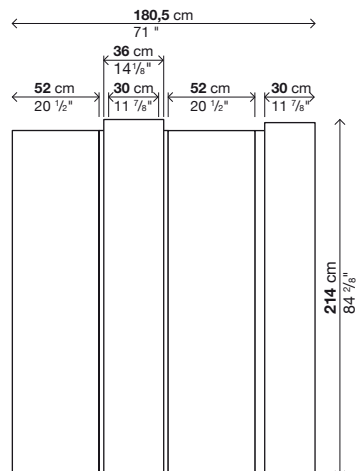
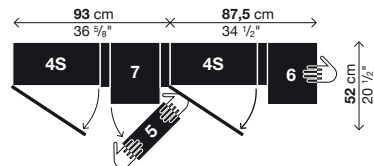

Code	Price in EURO	Packs	Vol. 3	Kg
55BLID1 + 55BLIF1		7	1,8	173

Composition B4
Unit B + Unit G

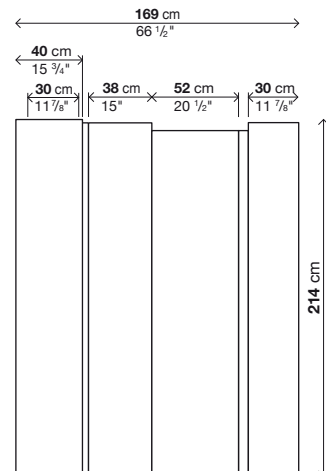
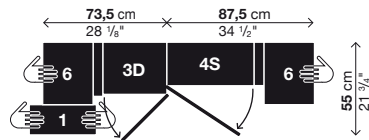

Code	Price in EURO	Packs	Vol. 3	Kg
55BLIB1 + 55BLIG1		10	2,07	194

Blio

Example layouts

Composition B5
Unit E + Unit C + Unit E

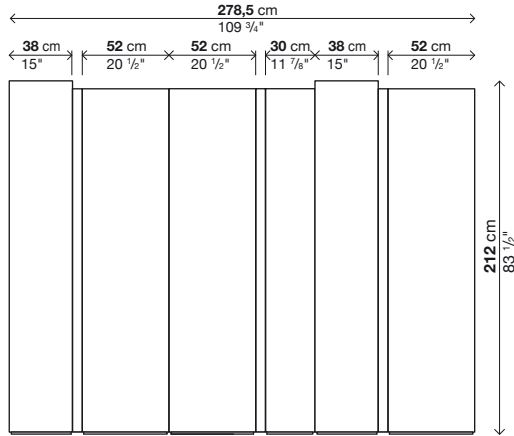
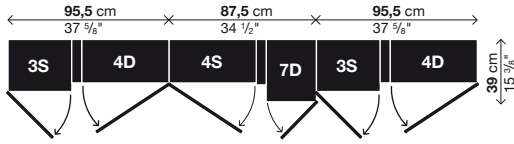

Code	Price in EURO	Packs	Vol. 3	Kg
55BLIE1 + 55BLIC1 + 55BLIE1		12	2,4	250

Composition B6
Unit A + Unit C + Unit F

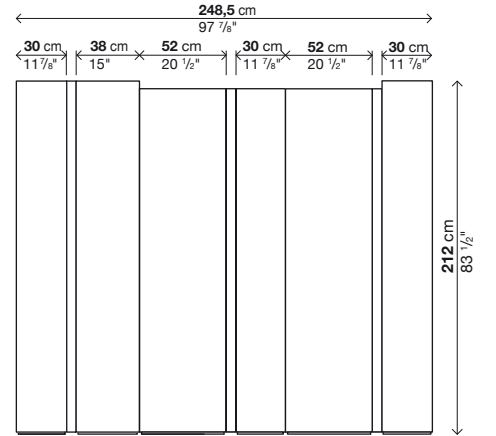
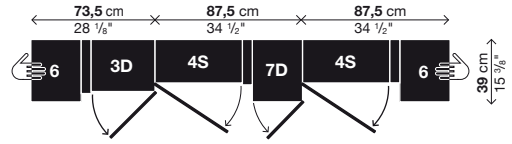

Code	Price in EURO	Packs	Vol. 3	Kg
55BLIA1 + 55BLIC1 + 55BLIF1		12	2,4	230

Composition B7
Unit C + Unit D + Unit F

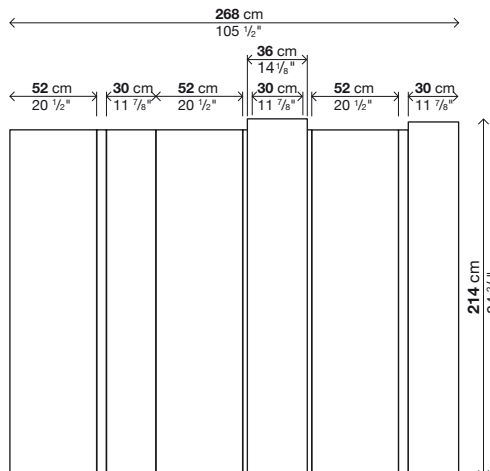
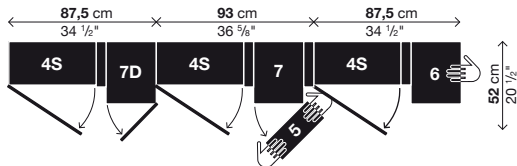

Code	Price in EURO	Packs	Vol. 3	Kg
55BLIC1 + 55BLID1 + 55BLIF1		11	2,6	255

Composition B8
Unit B + Unit D + Unit F

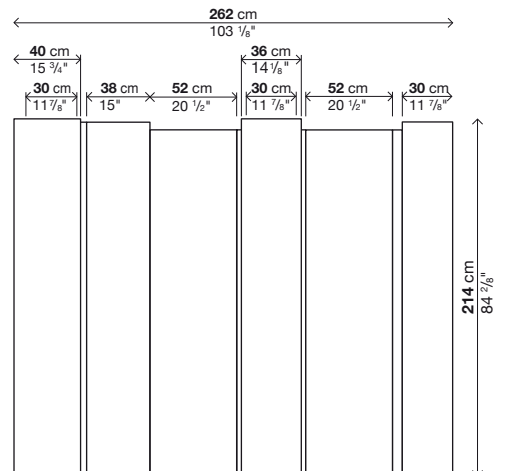
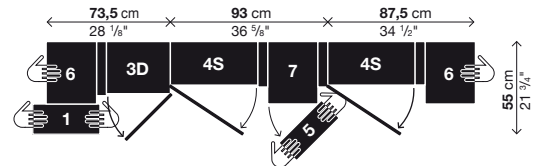

Code	Price in EURO	Packs	Vol. 3	Kg
55BLIB1 + 55BLID1 + 55BLIF1		12	2,82	268

Blio / Blio Solo

Finitura:

Mdf laccato bianco Ral 9010

Finitura ripiani portascarpe:

Acciaio verniciato beige

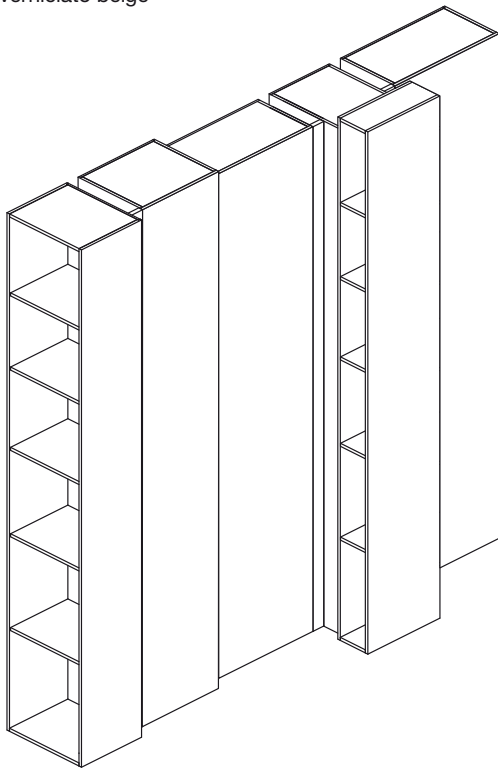

Blio (componibile)

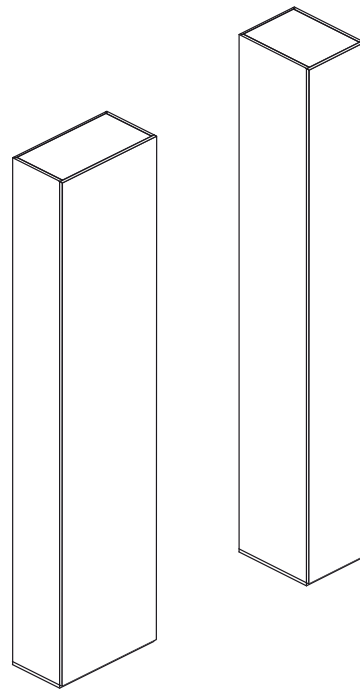

Blio Solo (elementi indipendenti)

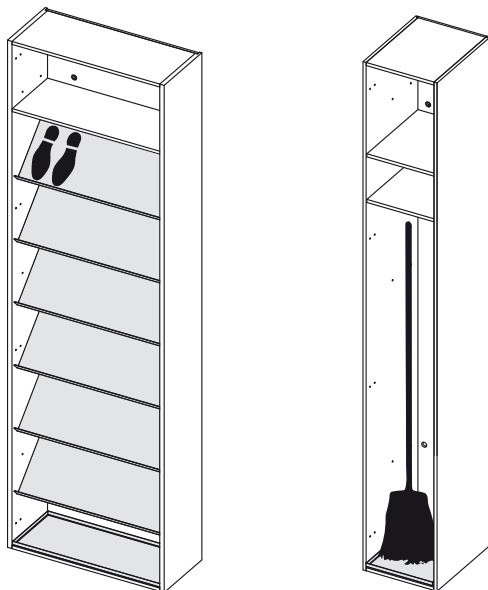

Ante con apertura "push-pull", spessore mm. 12.

I ripiani sono fissi (tranne nel caso dell'elemento portascarpe).

Non sono realizzabili elementi fuori misura.

Gli elementi devono necessariamente essere ancorati alla parete.

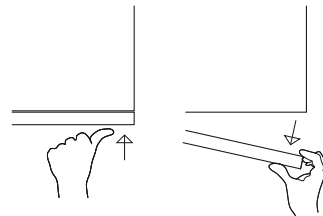

Nuovi elementi con accessori "portascarpe" e "portascoppe"

Blio / Blio Solo

L'utilizzo funzionale degli spazi:

I contenitori Blio sono adattati a ospitare non solo libri ma tutto quello che può servire in un ambiente domestico grazie alle differenti altezze dei vani.

Di seguito vengono riportati gli spazi interni.

I ripiani sono fissi (tranne nel caso dell'elemento portascarpe).

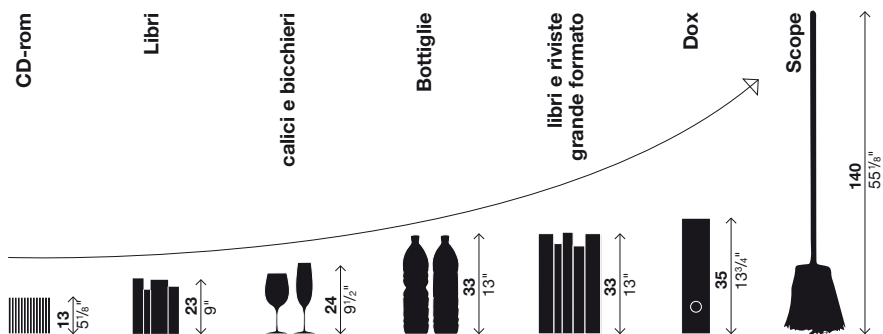

1

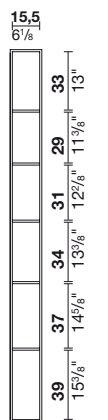

Prof. 40 cm
Depth 15 $\frac{3}{4}$ "

3

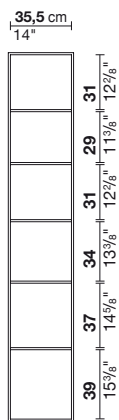

Prof. 29,5 cm
Depth 11 $\frac{5}{8}$ "

4

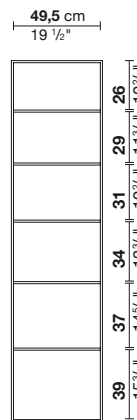

Prof. 24,5 cm
Depth 9 $\frac{3}{4}$ "

5

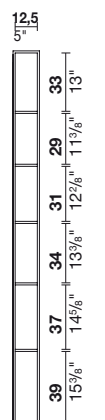

Prof. 36 cm
Depth 14 $\frac{1}{8}$ "

6

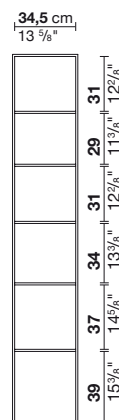

Prof. 28,5 cm
Depth 11 $\frac{2}{8}$ "

7

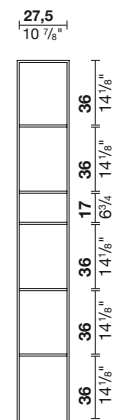

Prof. 36 cm
Depth 14 $\frac{1}{8}$ "

10

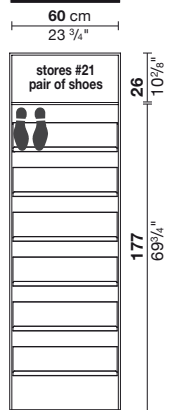

Prof. 24,5 cm
Depth 9 $\frac{3}{4}$ "

Nell'elemento 10 (portascarpe) i ripiani possono essere posizionati in obliquo oppure in piano.

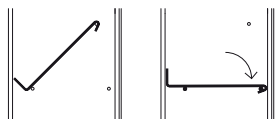

11

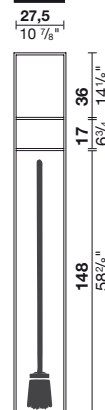

Prof. 36 cm
Depth 14 $\frac{1}{8}$ "

Blio Solo

Elemento 3

Elemento indipendente.

3

Codice	Prezzi EURO	colli	m ³	Kg
55BLI3D	dx	2	0,35	37,5
55BLI3S	sx	2	0,35	37,5

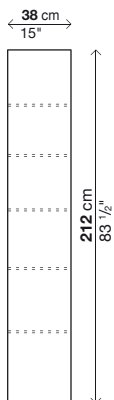
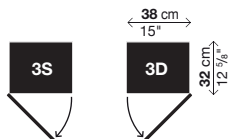

Elemento 4

Elemento indipendente.

4

Codice	Prezzi EURO	colli	m ³	Kg
55BLI4D	dx	2	0,4	41
55BLI4S	sx	2	0,4	41

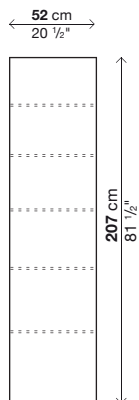
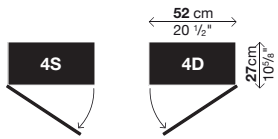

Elemento 7

Elemento indipendente.

7

Codice	Prezzi EURO	colli	m ³	Kg
55BLI7D	dx	2	0,32	37
55BLI7S	sx	2	0,32	37

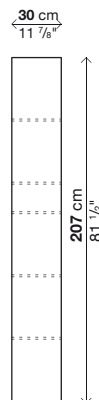
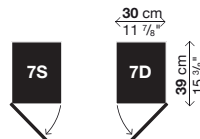
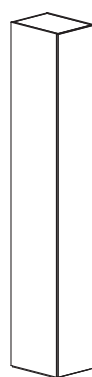

Elemento 10

Elemento indipendente.

10

Codice	Prezzi EURO	colli	m ³	Kg
55BLI10D	dx	3	0,52	60
55BLI10S	sx	3	0,52	60

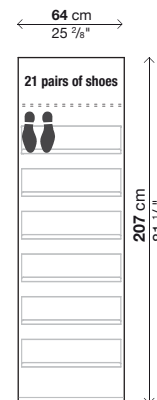
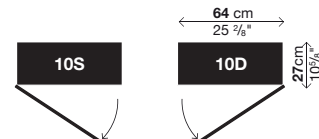

Blio Solo

Elemento 11

Elemento indipendente.

11

Codice	Prezzi EURO	colli	m ³	Kg
55BLI11D	dx	2	0,32	35
55BLI11S	sx	2	0,32	35

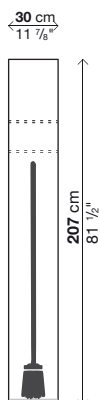
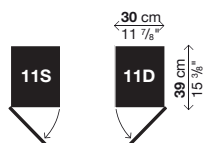
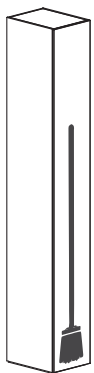

Blio

Componibile

Elemento A

Elemento indipendente o accostabile.

A

Codice	Prezzi EURO	colli	m ³	Kg
55BLIA1		4	0,76	71

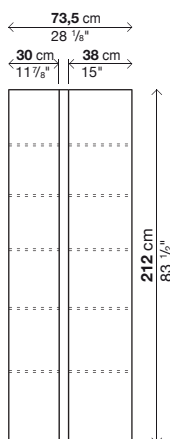
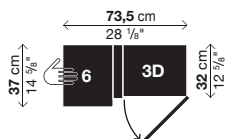
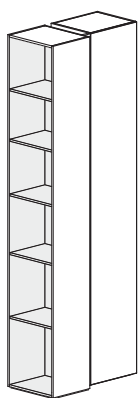

Elemento B

Elemento indipendente o accostabile.

B

Codice	Prezzi EURO	colli	m ³	Kg
55BLIB1		5	1,01	95

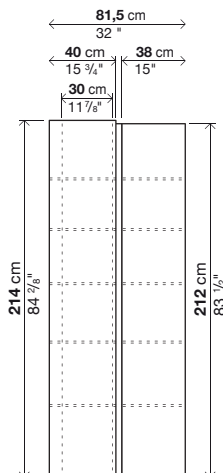
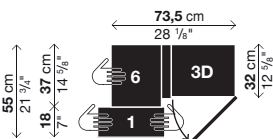
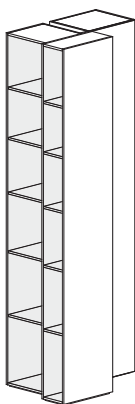

Elemento C

Elemento indipendente o accostabile.

C

Codice	Prezzi EURO	colli	m ³	Kg
55BLIC1		4	0,78	82

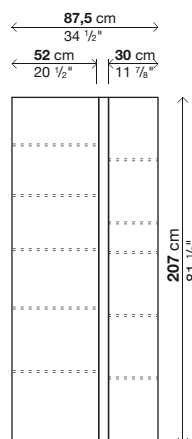
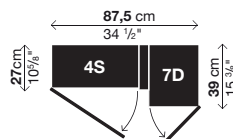
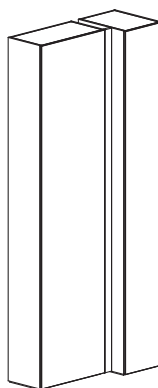

Elemento D

Elemento accostabile. Sul lato dx deve sempre esserci accostato un altro elemento.

D

Codice	Prezzi EURO	colli	m ³	Kg
55BLID1		3	1	98

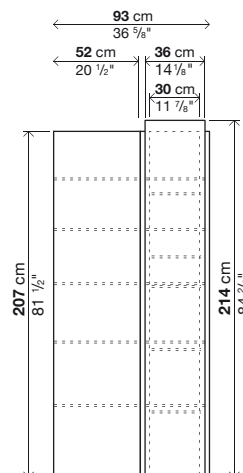
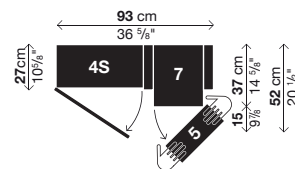
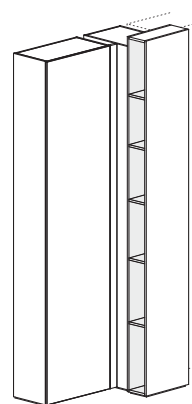

Blio

Componibile

Elemento E

Elemento indipendente o accostabile.

E

Codice	Prezzi EURO	colli	m ³	Kg
55BLIE1		4	0,8	83

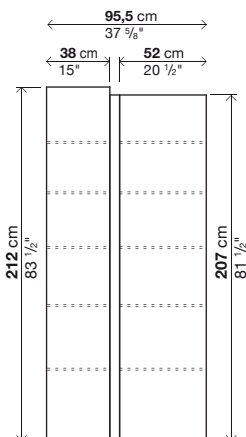
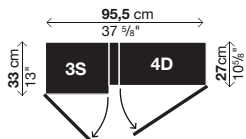
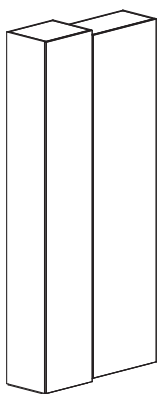

Elemento F

Elemento indipendente o accostabile.

F

Codice	Prezzi EURO	colli	m ³	Kg
55BLIF1		4	0,81	75

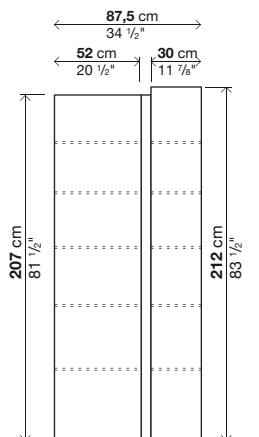
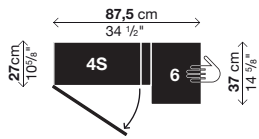
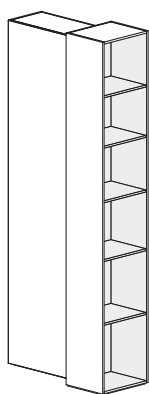

Elemento G

Elemento indipendente o accostabile.

G

Codice	Prezzi EURO	colli	m ³	Kg
55BLIG1		5	1,06	99

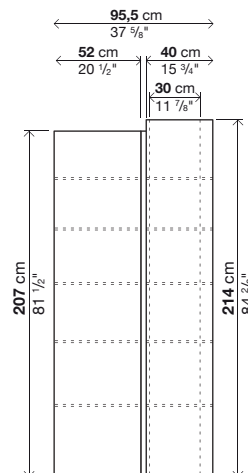
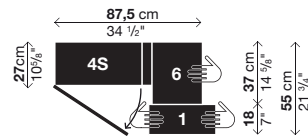
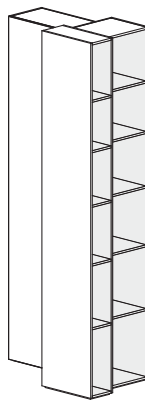

Blio accessori

Componibile

Elemento L

Elemento indipendente o accostabile.

L

Codice	Prezzi EURO	colli	m ³	Kg
55BLIL1		5	0,9	101

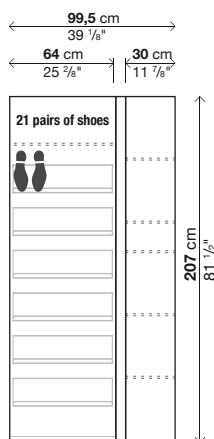
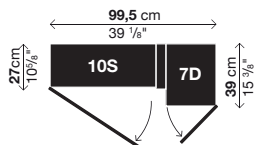
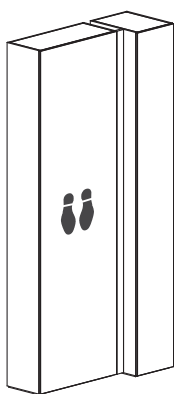

Elemento M

Elemento accostabile.
Sul lato dx deve sempre esserci accostato un altro elemento.

M

Codice	Prezzi EURO	colli	m ³	Kg
55BLIM1		4	1,1	118

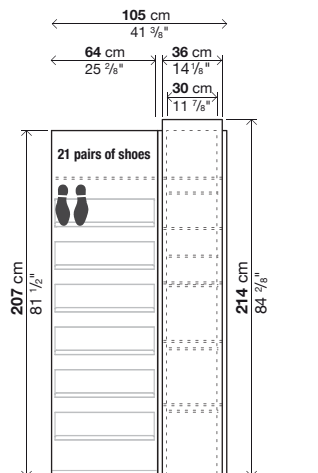
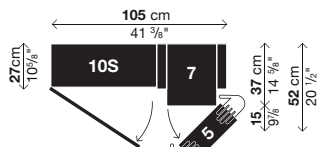
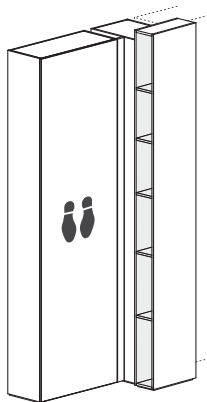

Elemento N

Elemento indipendente o accostabile.

N

Codice	Prezzi EURO	colli	m ³	Kg
55BLIN1		5	0,93	102

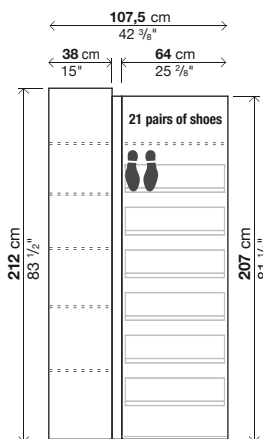
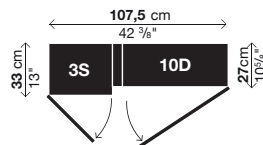
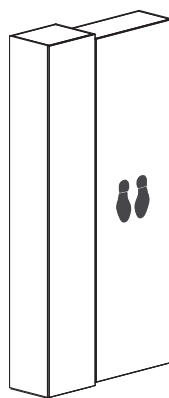

Elemento O

Elemento indipendente o accostabile.

O

Codice	Prezzi EURO	colli	m ³	Kg
55BLIO1		5	0,93	94

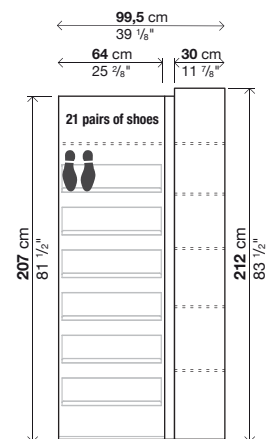
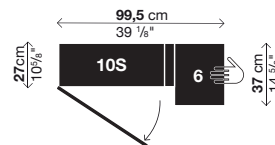
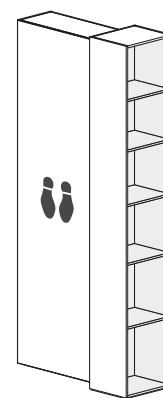

Blio accessori

Componibile

Elemento P

Elemento indipendente o accostabile.

P

Codice	Prezzi EURO	colli	m ³	Kg
55BLIP1		6	1,2	118

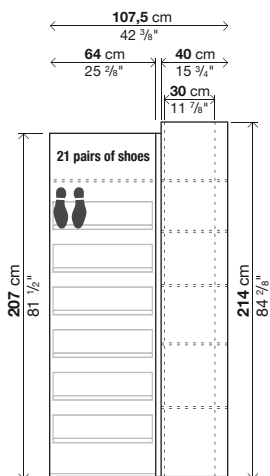
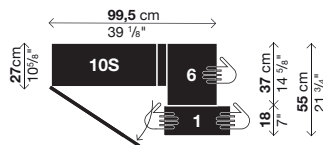
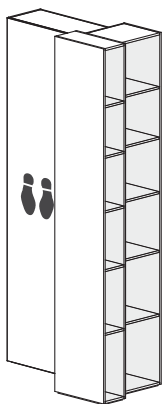

Elemento R

Elemento indipendente o accostabile.

R

Codice	Prezzi EURO	colli	m ³	Kg
55BLIR1		5	0,78	80

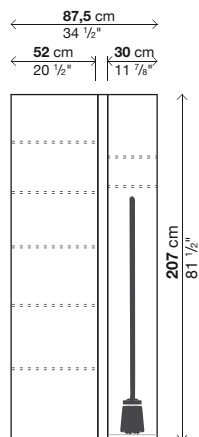
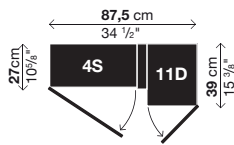
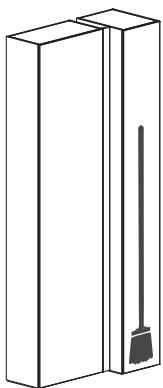

Elemento S

Elemento indipendente o accostabile.

S

Codice	Prezzi EURO	colli	m ³	Kg
55BLIS1		5	0,9	100

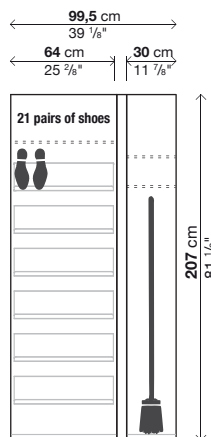
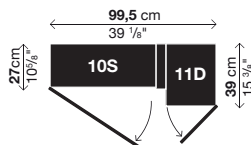
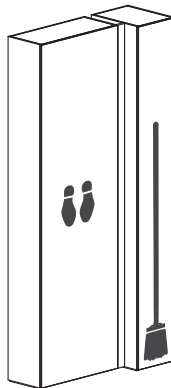

Blio

Esempi di composizione

Composizione B1
Elemento C + Elemento E

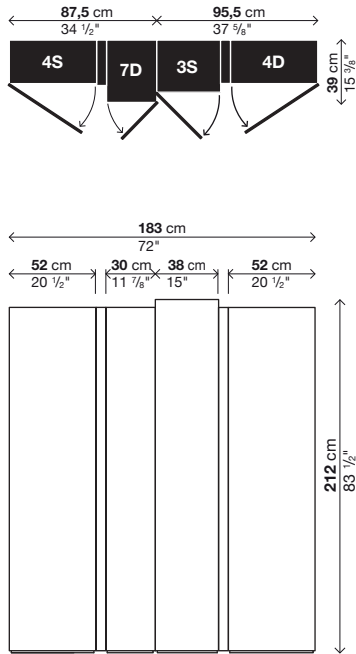

Codice	Prezzi EURO	colli	m ³	Kg
55BLIC1 + 55BLIE1		8	1,6	165

Composizione B2
Elemento A + Elemento F

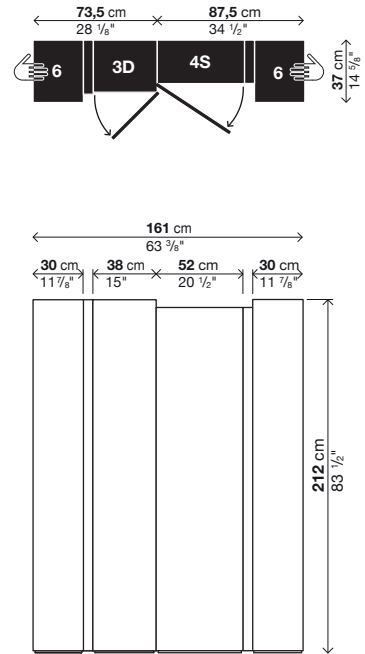

Codice	Prezzi EURO	colli	m ³	Kg
55BLIA1 + 55BLIF1		8	1,6	146

Composizione B3
Elemento D + Elemento F

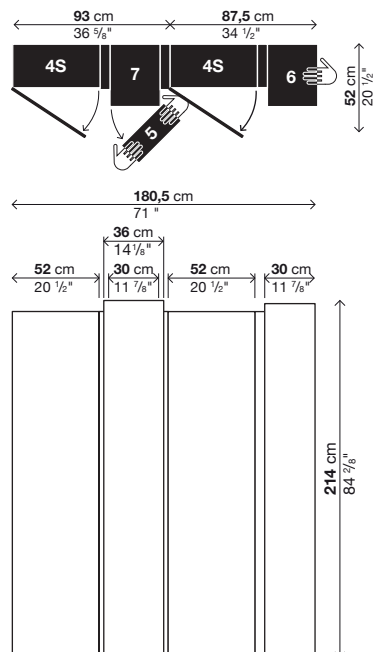

Codice	Prezzi EURO	colli	m ³	Kg
55BLID1 + 55BLIF1		7	1,8	173

Composizione B4
Elemento B + Elemento G

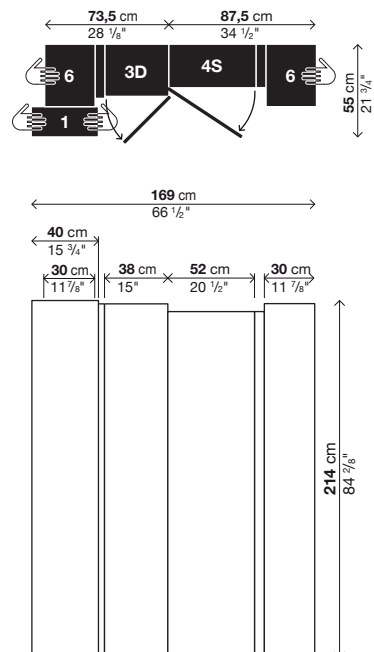

Codice	Prezzi EURO	colli	m ³	Kg
55BLIB1 + 55BLIG1		10	2,07	194

Blio

Esempi di composizione

Composizione B5

Elemento E + Elemento C + Elemento E

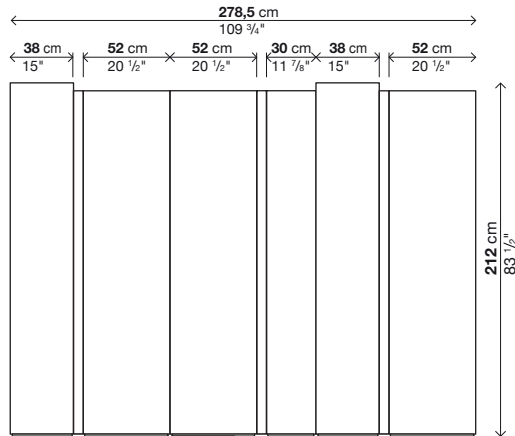
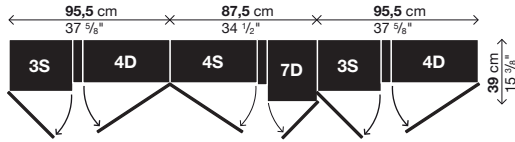

Codice	Prezzi EURO	colli	m ³	Kg
55BLIE1 + 55BLIC1 + 55BLIE1		12	2,4	250

Composizione B6

Elemento A + Elemento C + Elemento F

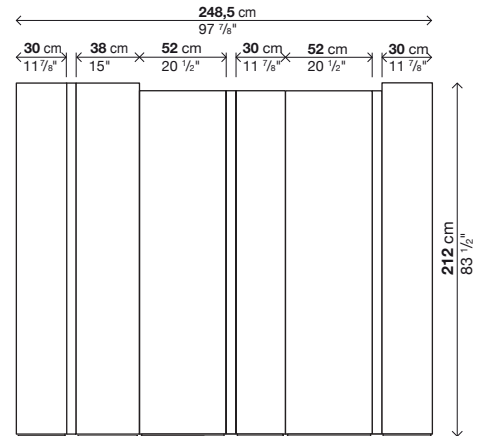
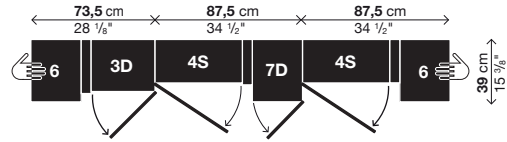

Codice	Prezzi EURO	colli	m ³	Kg
55BLIA1 + 55BLIC1 + 55BLIF1		12	2,4	230

Composizione B7

Elemento C + Elemento D + Elemento F

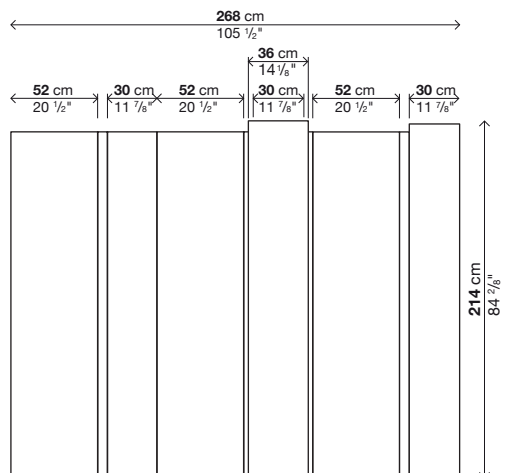
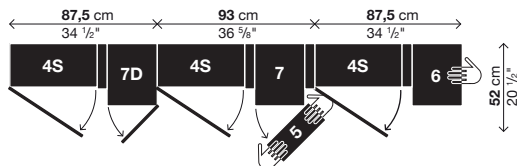

Codice	Prezzi EURO	colli	m ³	Kg
55BLIC1 + 55BLID1 + 55BLIF1		11	2,6	255

Composizione B8

Elemento B + Elemento D + Elemento F

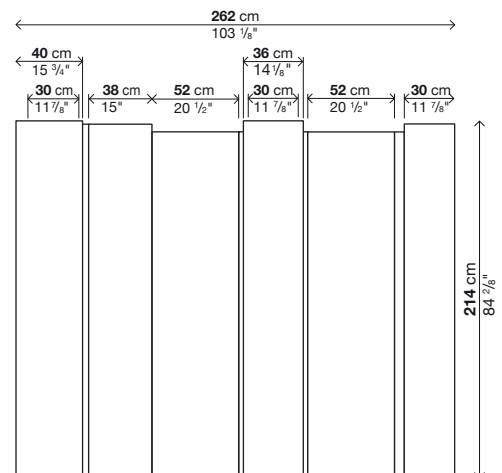
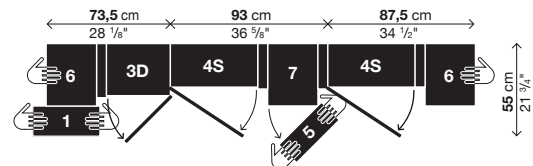

Codice	Prezzi EURO	colli	m ³	Kg
55BLIB1 + 55BLID1 + 55BLIF1		12	2,82	268

Blio / Blio Solo

Finitions:

Mdf laqué blanc Ral 9010

Finition étagères range-chaussures:

Acier laqué beige

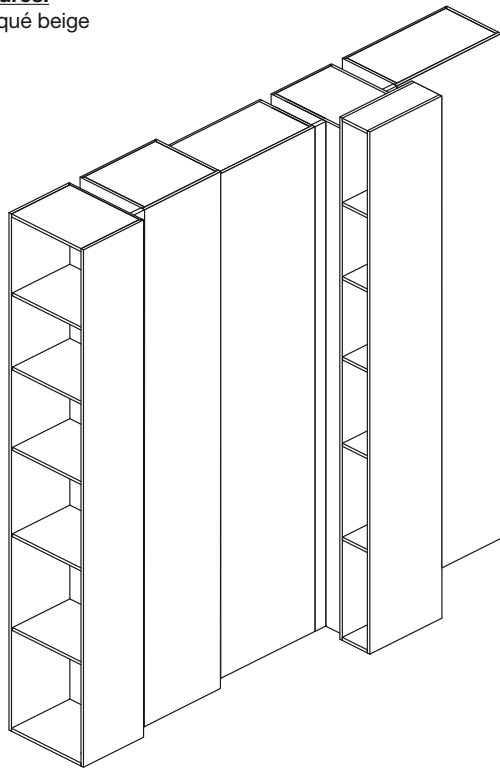

Blio (composable)

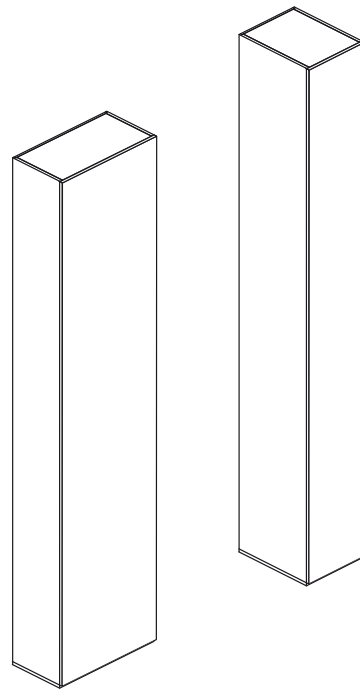

Blio Solo (éléments individuels)

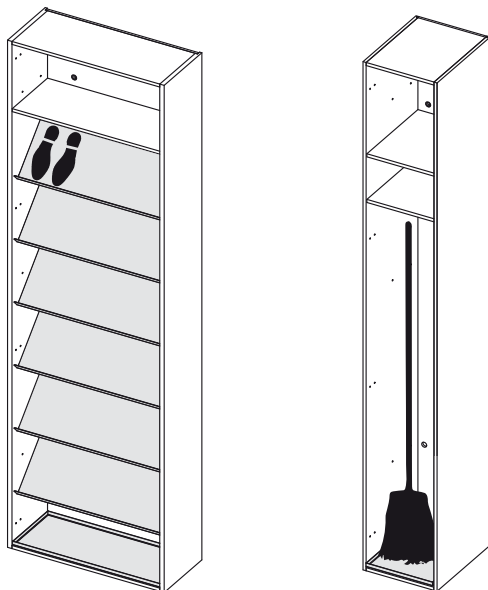

Portes à ouverture "touche-lâche", épaisseur mm. 12.
Les étagères sont fixes (excepté sur l'élément range-chaussures).
Éléments sur mesure non réalisables.
Les éléments doivent impérativement être ancrés à un mur.

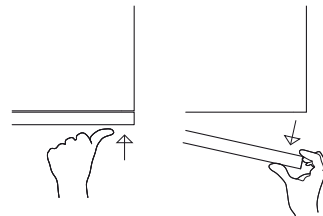

Nouveaux éléments avec accessoires "range-chaussures" et "range-balais"

Blio / Blio Solo

Utilisation fonctionnelle des espaces:

Les meubles de rangement Blio sont très pratiques pour y loger non seulement des livres mais également tout ce dont on a besoin au quotidien, grâce aux compartiments placés à différentes hauteurs.

Ci-dessous sont indiqués les espaces internes

Les étagères sont fixes (excepté sur l'élément range-chaussures).

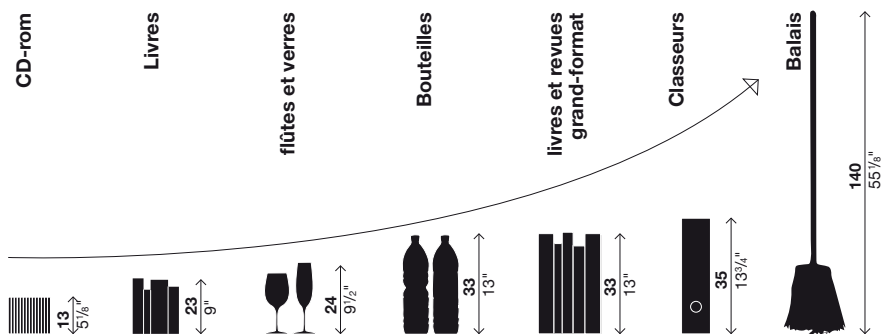

1

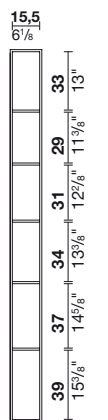

Prof. 40 cm
Depth 15 3/4"

3

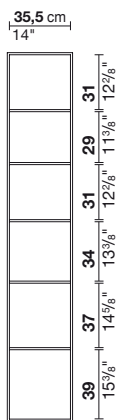

Prof. 29,5 cm
Depth 11 5/8"

4

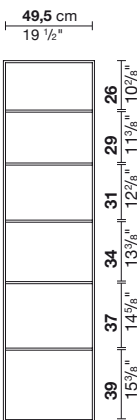

Prof. 24,5 cm
Depth 9 3/4"

5

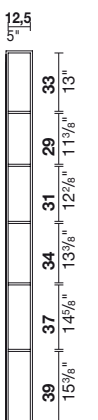

Prof. 36 cm
Depth 14 1/8"

6

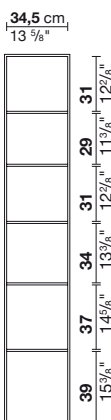

Prof. 28,5 cm
Depth 11 2/8"

7

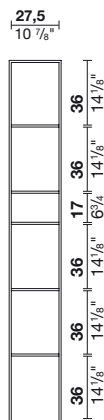

Prof. 36 cm
Depth 14 1/8"

10

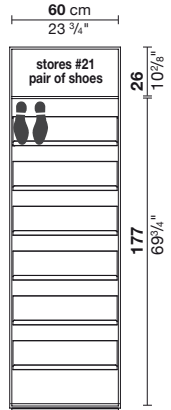

Prof. 24,5 cm
Depth 9 3/4"

Sur l'élément 10 (range-chaussures), les étagères peuvent être montées inclinées ou bien à plat.



11

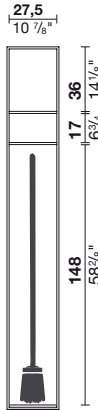

Prof. 36 cm
Depth 14 1/8"

Blio Solo

Élément 3

Élément individuel.

3

Code	Prix en EURO	Colis : m ³	Kg
55BLI3D	D	2	0,35 37,5
55BLI3S	G	2	0,35 37,5

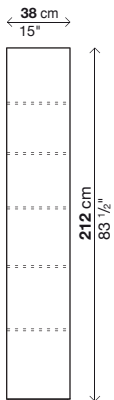
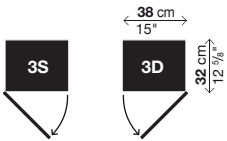
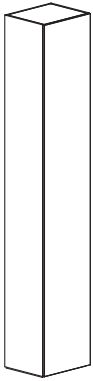

Élément 4

Élément individuel.

4

Code	Prix en EURO	Colis : m ³	Kg
55BLI4D	D	2	0,4 41
55BLI4S	G	2	0,4 41

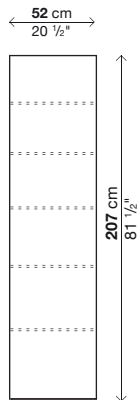
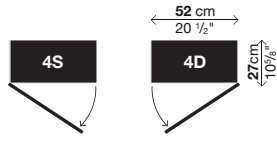
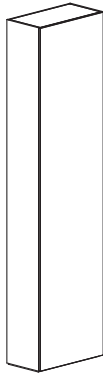

Élément 7

Élément individuel.

7

Code	Prix en EURO	Colis : m ³	Kg
55BLI7D	D	2	0,32 37
55BLI7S	G	2	0,32 37

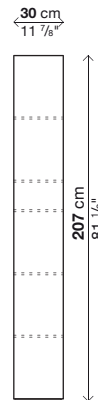
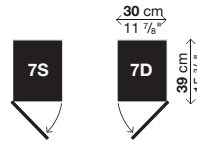
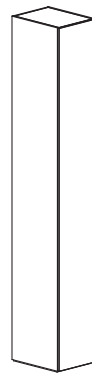

Élément 10

Élément individuel.

10

Code	Prix en EURO	Colis : m ³	Kg
55BLI10D	D	3	0,52 60
55BLI10S	G	3	0,52 60

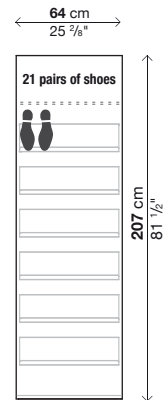
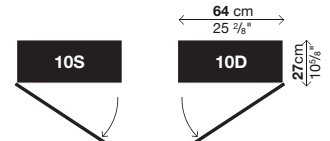

Blio Solo

Élément 11

Élément individuel.

11

Code	Prix en EURO	Colis	m ³	Kg
55BLI11D	D	2	0,32	35
55BLI11S	G	2	0,32	35

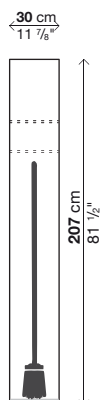
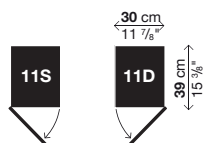
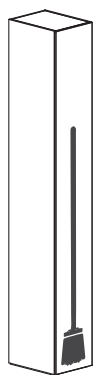

Blio

Composable

Élément A

Élément individuel ou à juxtaposer.

A

Code	Prix en EURO	Colis : m ³	Kg
55BLIA1		4	0,76 71

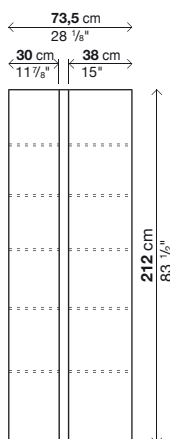
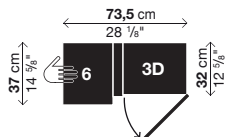
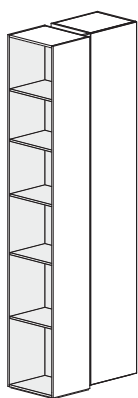

Élément B

Élément individuel ou à juxtaposer.

B

Code	Prix en EURO	Colis : m ³	Kg
55BLIB1		5	1,01 95

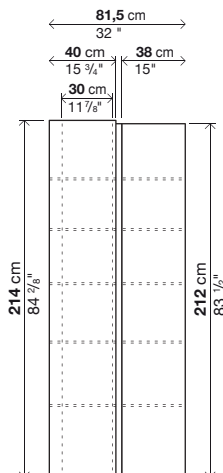
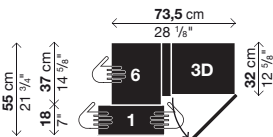
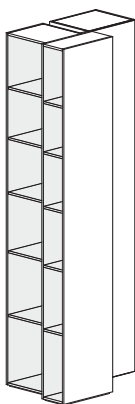

Élément C

Élément individuel ou à juxtaposer.

C

Code	Prix en EURO	Colis : m ³	Kg
55BLIC1		4	0,78 82

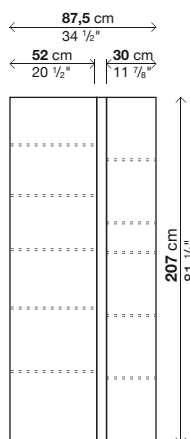
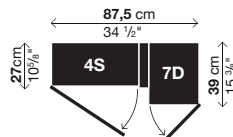
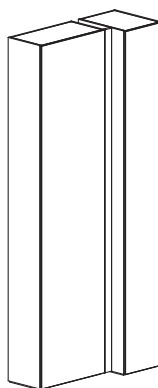

Élément D

Élément à juxtaposer.
Il faut impérativement installer un autre élément sur le côté droit.

D

Code	Prix en EURO	Colis : m ³	Kg
55BLID1		3	1 98

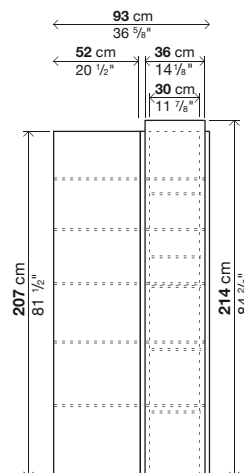
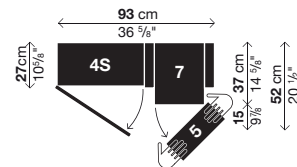
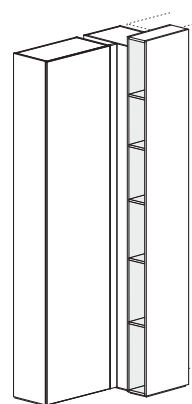

Blio

Composable

Élément E

Élément individuel ou à juxtaposer.

E

Code	Prix en EURO	Colis : m ³	Kg
55BLIE1		4 : 0,8	83

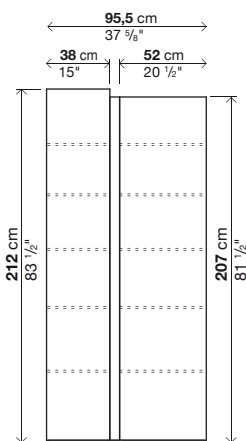
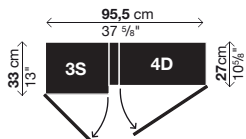
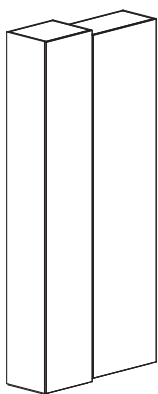

Élément F

Élément individuel ou à juxtaposer.

F

Code	Prix en EURO	Colis : m ³	Kg
55BLIF1		4 : 0,81	75

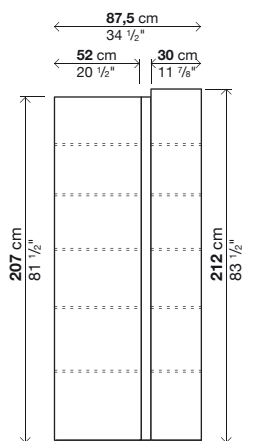
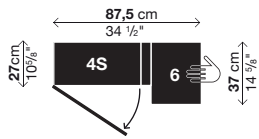
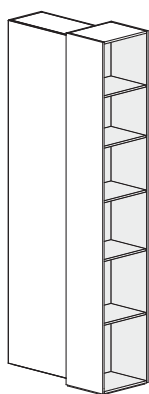

Élément G

Élément individuel ou à juxtaposer.

G

Code	Prix en EURO	Colis : m ³	Kg
55BLIG1		5 : 1,06	99

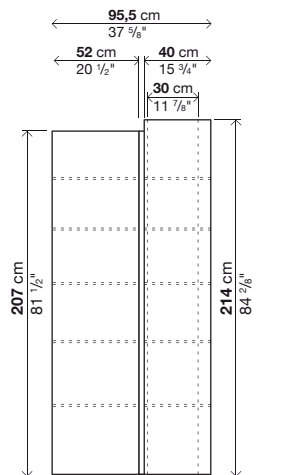
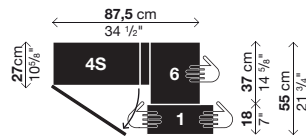
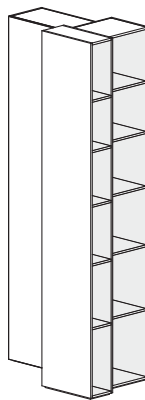

Blio accessoires Composable

Élément L

Élément individuel ou à juxtaposer.

L

Code	Prix en EURO	Colis : m³	Kg
55BLIL1		5	0,9 : 101

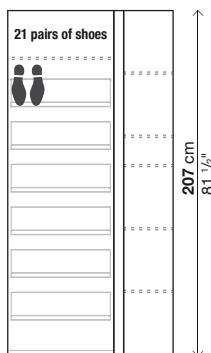
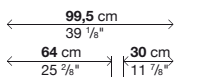
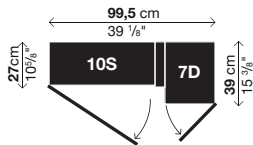
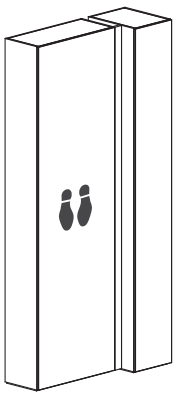

Élément M

Élément à juxtaposer.
Il faut impérativement installer un autre élément sur le côté droit.

M

Code	Prix en EURO	Colis : m³	Kg
55BLIM1		4	1,1 : 118

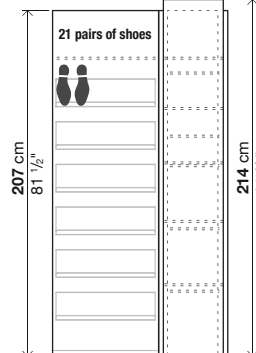
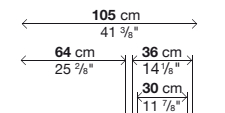
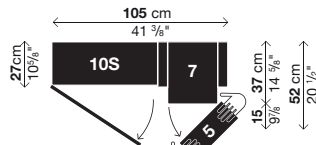
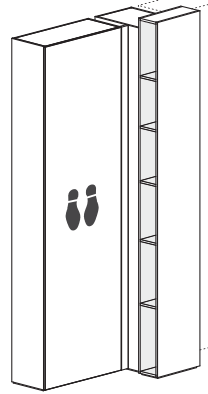

Élément N

Élément individuel ou à juxtaposer.

N

Code	Prix en EURO	Colis : m³	Kg
55BLIN1		5	0,93 : 102

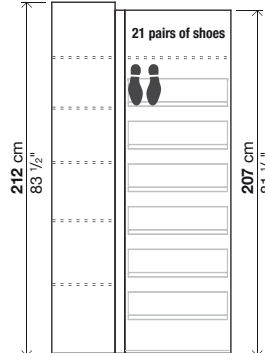
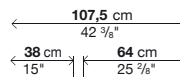
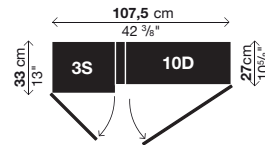
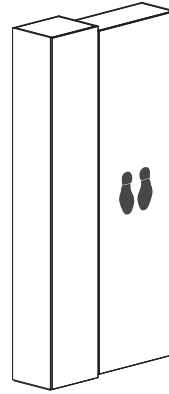

Élément O

Élément individuel ou à juxtaposer.

O

Code	Prix en EURO	Colis : m³	Kg
55BLIO1		5	0,93 : 94

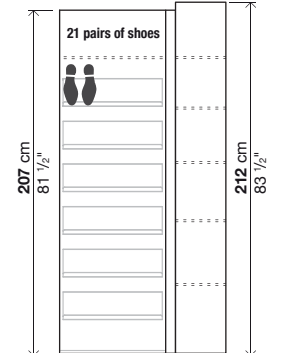
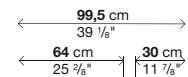
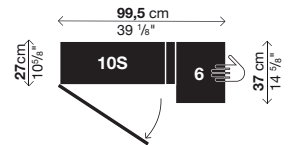
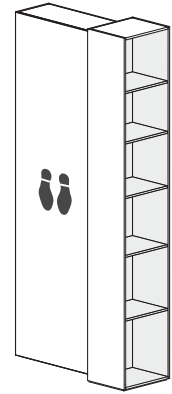

Blio accessoires Composable

Élément P

Élément individuel ou à juxtaposer.

P

Code	Prix en EURO	Colis : m ³	Kg
55BLIP1		6 : 1,2	118

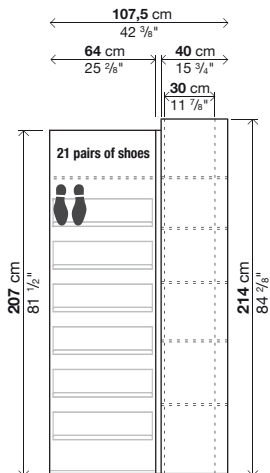
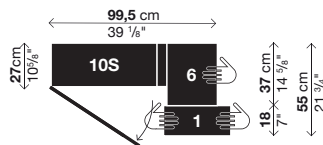
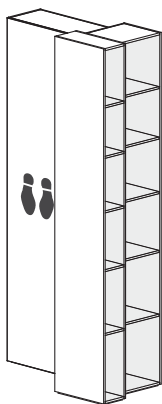

Élément R

Élément individuel ou à juxtaposer.

R

Code	Prix en EURO	Colis : m ³	Kg
55BLIR1		5 : 0,78	80

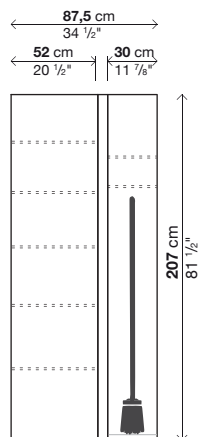
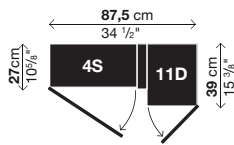
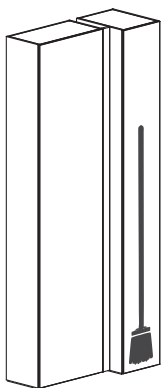

Élément S

Élément individuel ou à juxtaposer.

S

Code	Prix en EURO	Colis : m ³	Kg
55BLIS1		5 : 0,9	100

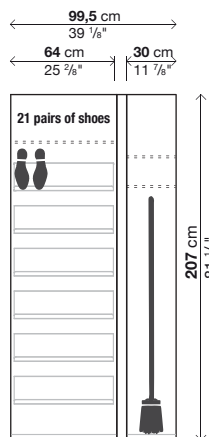
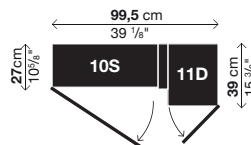
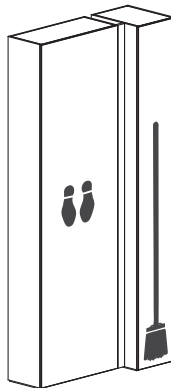

Blio

Exemples de composition

Composition B1
Élément C + Élément E

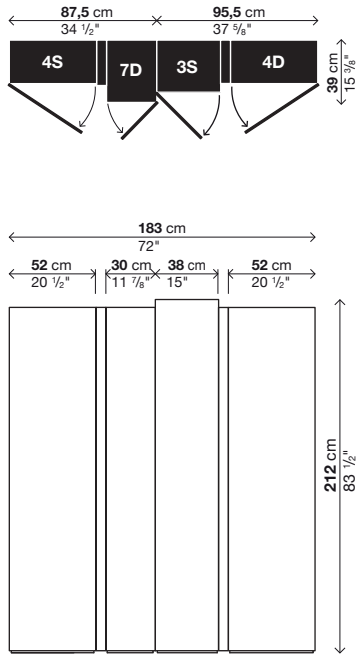

Code	Prix en EURO	Cols	m ³	Kg
55BLIC1 + 55BLIE1		8	1,6	165

Composition B2
Élément A + Élément F

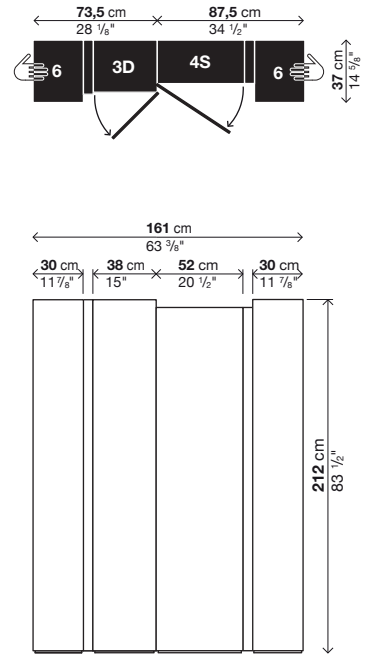

Code	Prix en EURO	Cols	m ³	Kg
55BLIA1 + 55BLIF1		8	1,6	146

Composition B3
Élément D + Élément F

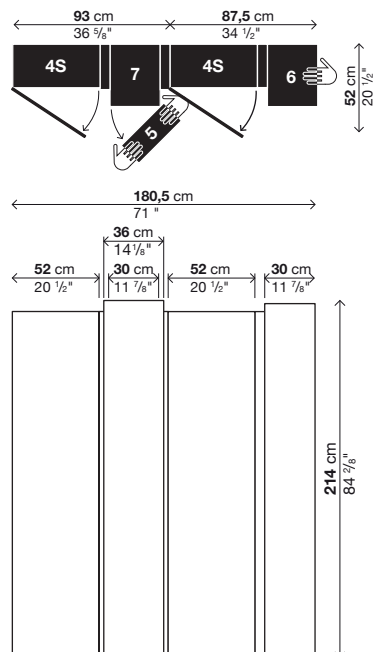

Code	Prix en EURO	Cols	m ³	Kg
55BLID1 + 55BLIF1		7	1,8	173

Composition B4
Élément B + Élément G

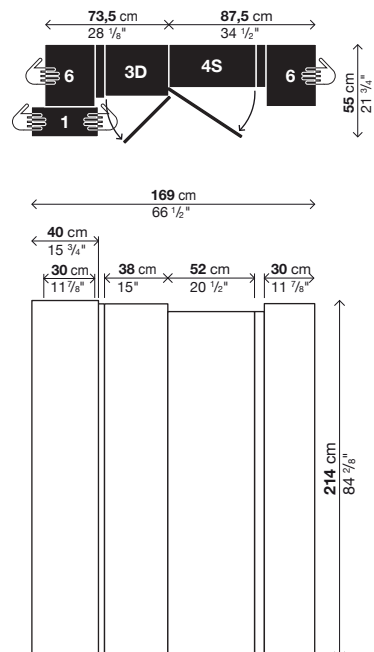

Code	Prix en EURO	Cols	m ³	Kg
55BLIB1 + 55BLIG1		10	2,07	194

Blio

Exemples de composition

Composition B5

Élément E + Élément C + Élément E

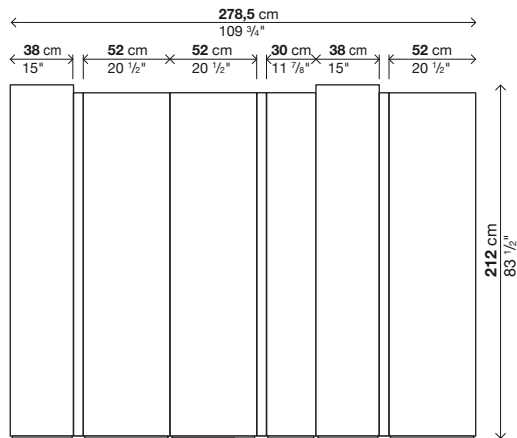
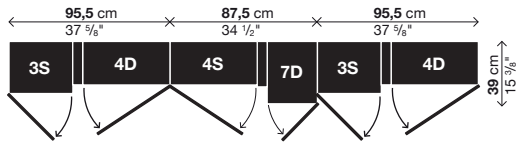

Code	Prix en EURO	Cols	m ³	Kg
55BLIE1 + 55BLIC1 + 55BLIE1	12	2,4	250	

Composition B6

Élément A + Élément C + Élément F

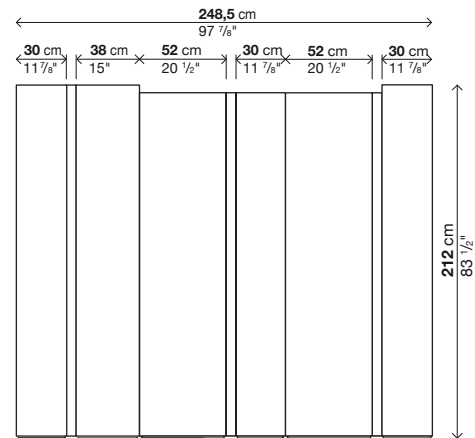
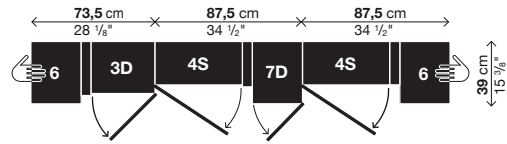

Code	Prix en EURO	Cols	m ³	Kg
55BLIA1 + 55BLIC1 + 55BLIF1	12	2,4	230	

Composition B7

Élément C + Élément D + Élément F

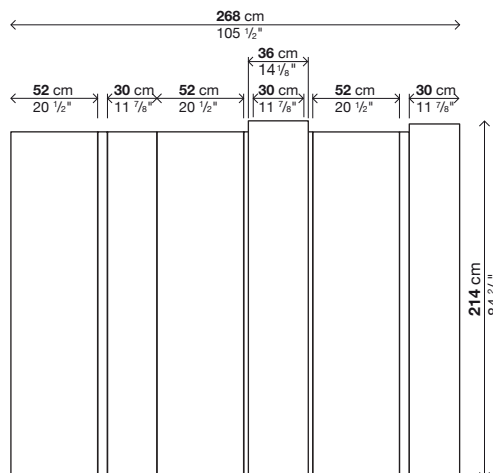
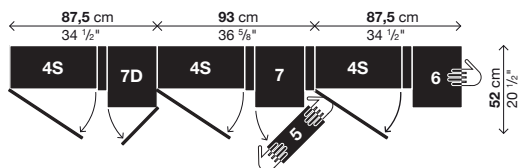

Code	Prix en EURO	Cols	m ³	Kg
55BLIC1 + 55BLID1 + 55BLIF1	11	2,6	255	

Composition B8

Élément B + Élément D + Élément F

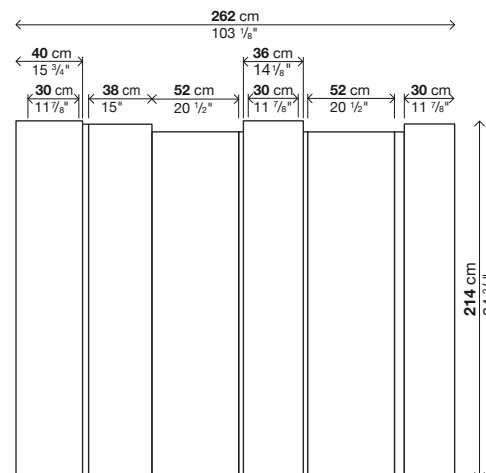
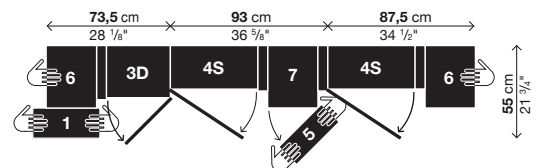

Code	Prix en EURO	Cols	m ³	Kg
55BLIB1 + 55BLID1 + 55BLIF1	12	2,82	268	

Blio / Blio Solo

Ausführung:

MDF weiß lackiert Ral 9010

Ausführung der Schuh-

Fachböden:

Beige lackierter Stahl

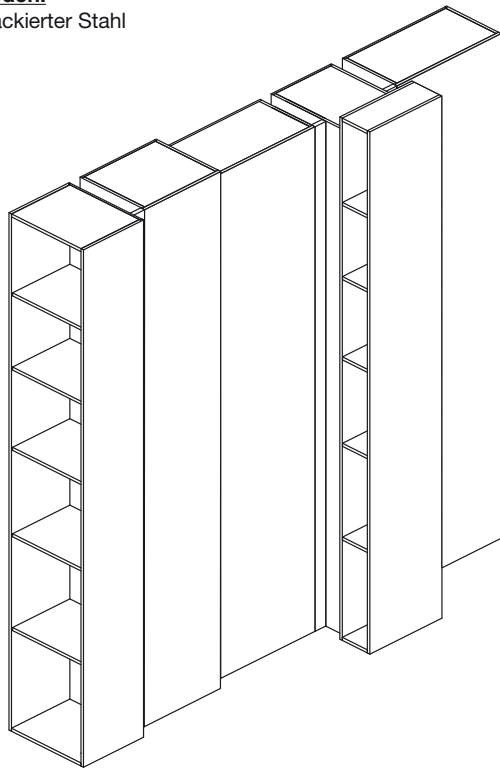

Blio (anbaufähig)

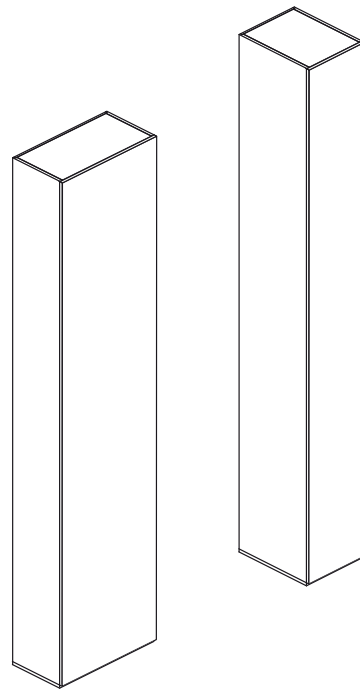

Blio Solo (allein stehende Elemente)

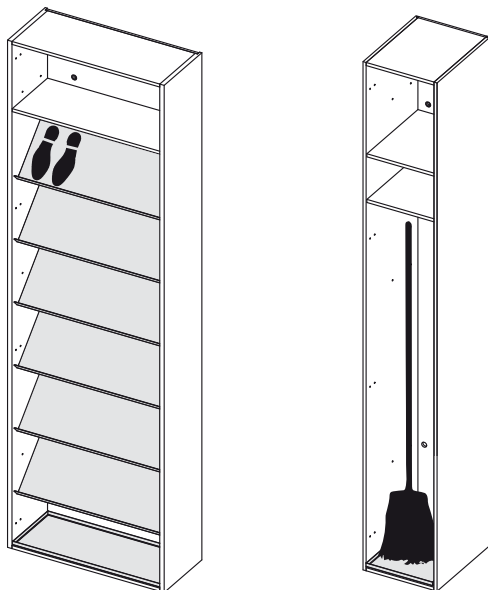

Türen mit "Push-Pull-System", Stärke 12 mm.
Die Fachböden sind fix befestigt (außer jene des Schuhschranks).
Es können keine Elemente mit Sondermaßen hergestellt werden.
Die Elemente müssen unbedingt an der Wand befestigt werden.

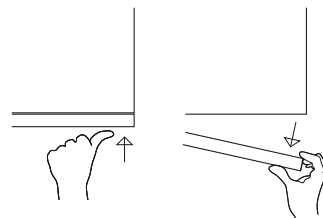

Neue Elemente "Schuhschrank" und "Besenschrank" mit Zubehörteilen

Blio / Blio Solo

Die funktionelle Verwendung der Fächer:

Die Möbelemente Blio sind nicht nur zur Unterbringung von Büchern geeignet, sondern können dank der unterschiedlichen Höhe der Fächer alle in einem häuslichen Ambiente nützlichen Dinge aufnehmen. Nachfolgend werden die Innenräume dargestellt. Die Fachböden sind fix befestigt (außer jene des Schuhschranks).

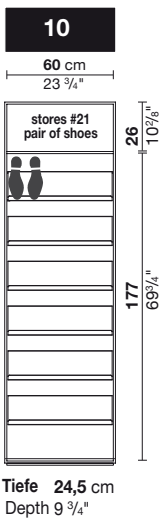
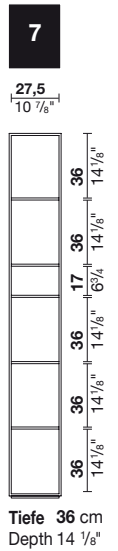
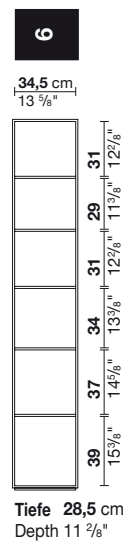
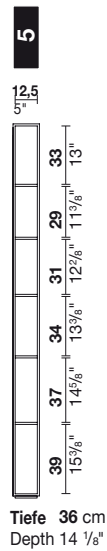
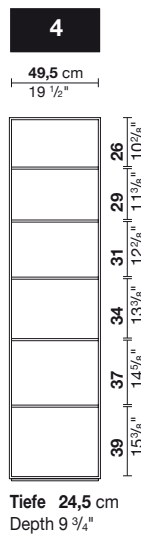
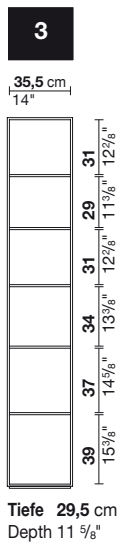
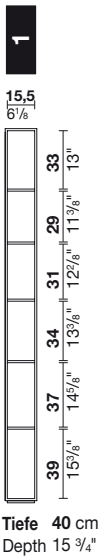
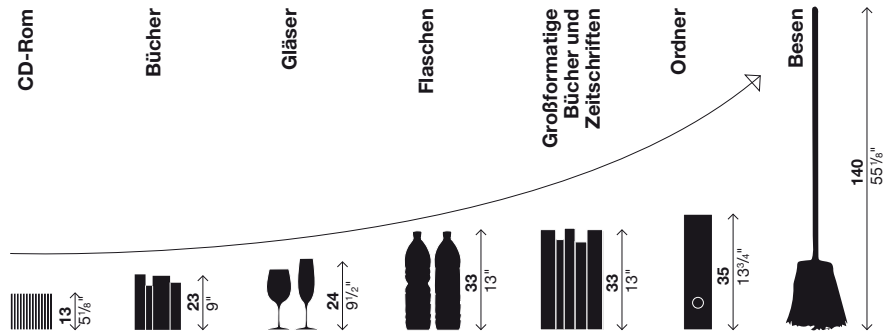

Im Element 10 (Schuhschrank) können die Fachböden schräg oder gerade eingesetzt werden.

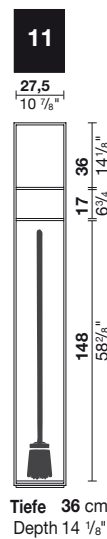
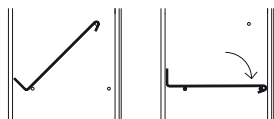

Blio Solo

Element 3

Allein stehendes Element.

3

Art.-Nr.	Preis in EURO	Koli	V. m ³	Kg
55BLI3D	re	2	0,35	37,5
55BLI3S	li	2	0,35	37,5

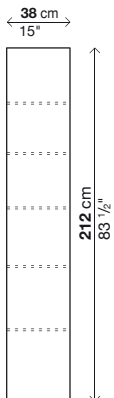
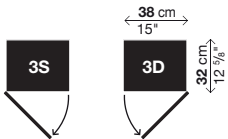
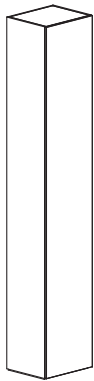

Element 4

Allein stehendes Element.

4

Art.-Nr.	Preis in EURO	Koli	V. m ³	Kg
55BLI4D	re	2	0,4	41
55BLI4S	li	2	0,4	41

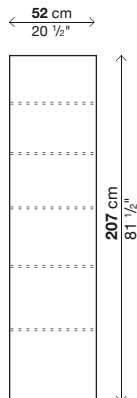
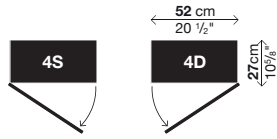

Element 7

Allein stehendes Element.

7

Art.-Nr.	Preis in EURO	Koli	V. m ³	Kg
55BLI7D	re	2	0,32	37
55BLI7S	li	2	0,32	37

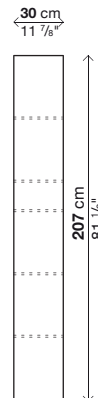
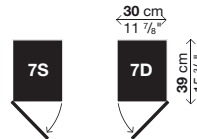
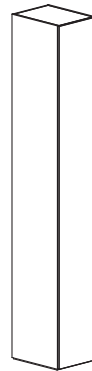

Element 10

Allein stehendes Element.

10

Art.-Nr.	Preis in EURO	Koli	V. m ³	Kg
55BLI10D	re	3	0,52	60
55BLI10S	li	3	0,52	60

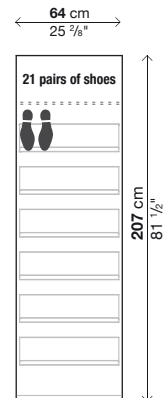
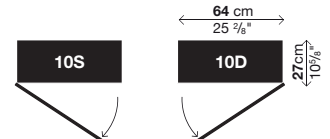

Blio Solo

Element 11

Allein stehendes Element.

11

Art.-Nr.		Preis in EURO	Kolle V. m ²	Kg	
55BLI11D	re		2	0,32	35
55BLI11S	li		2	0,32	35

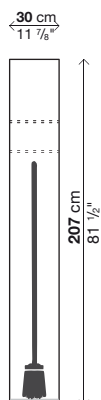
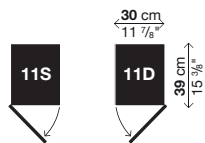
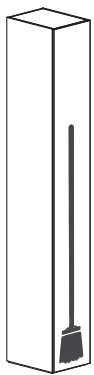

Blio

Anbaufähig

Element A

Allein stehendes oder anbaufähiges Element.

A

Art.-Nr.	Preis in EURO	Kölli V.m ³ Kg
55BLIA1		4 0,76 71

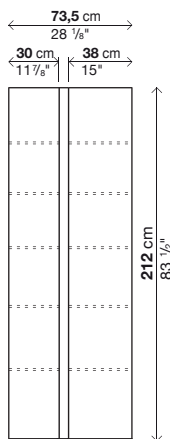
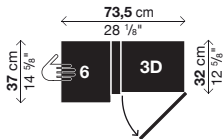
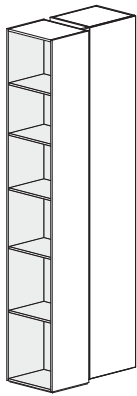

Element B

Allein stehendes oder anbaufähiges Element.

B

Art.-Nr.	Preis in EURO	Kölli V.m ³ Kg
55BLIB1		5 1,01 95

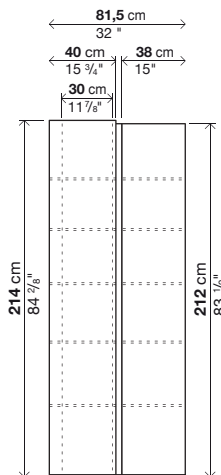
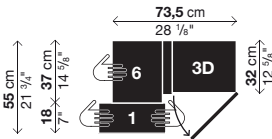
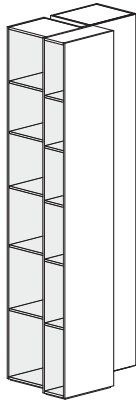

Element C

Allein stehendes oder anbaufähiges Element.

C

Art.-Nr.	Preis in EURO	Kölli V.m ³ Kg
55BLIC1		4 0,78 82

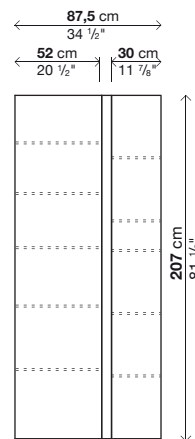
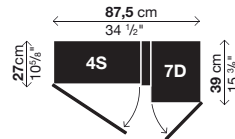
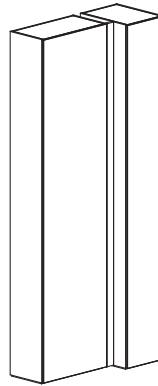

Element D

Anbaufähiges Element
Auf der rechten Seite muss
immer ein anderes Element
angebaut werden.

D

Art.-Nr.	Preis in EURO	Kölli V.m ³ Kg
55BLID1		3 1 98

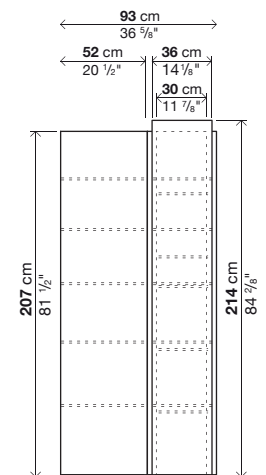
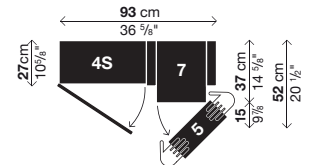
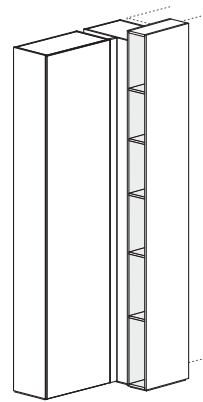

Blio

Anbaufähig

Element E

Allein stehendes oder anbaufähiges Element.

E

Art.-Nr.	Preis in EURO	Kollekt. V. m ³ Kg
55BLIE1		4 0,8 83

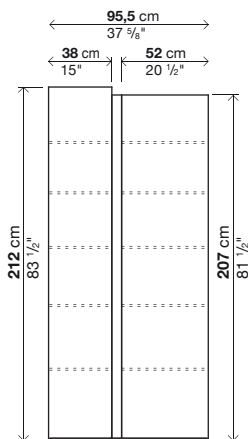
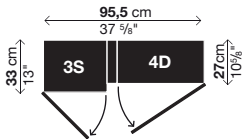
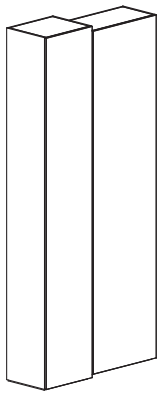

Element F

Allein stehendes oder anbaufähiges Element.

F

Art.-Nr.	Preis in EURO	Kollekt. V. m ³ Kg
55BLIF1		4 0,81 75

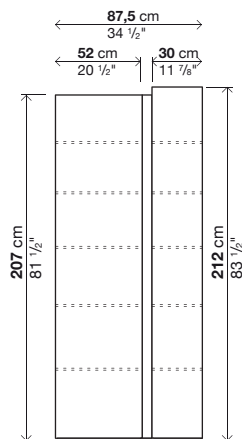
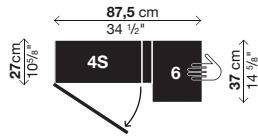
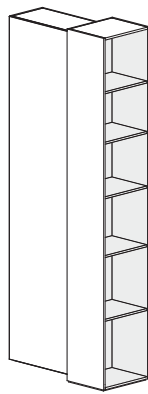

Element G

Allein stehendes oder anbaufähiges Element.

G

Art.-Nr.	Preis in EURO	Kollekt. V. m ³ Kg
55BLIG1		5 1,06 99

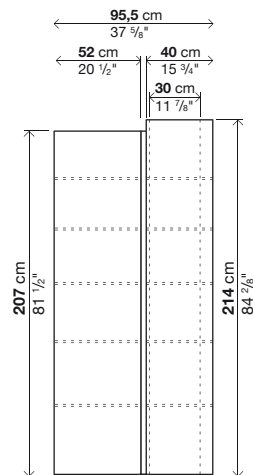
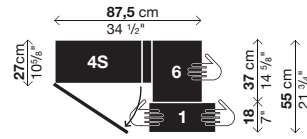
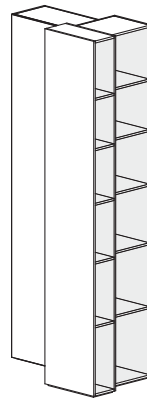

Blio Zusatzelemente

Anbaufähig

Element L

Allein stehendes oder anbaufähiges Element.

L

Art.-Nr.	Preis in EURO	Kolli	V.m ³	Kg
55BLIL1		5	0,9	101

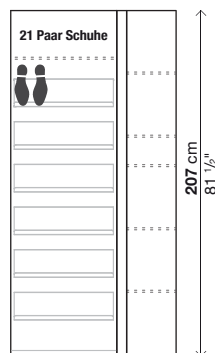
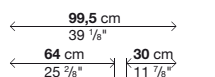
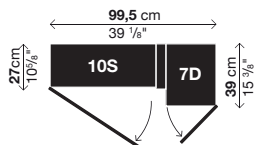
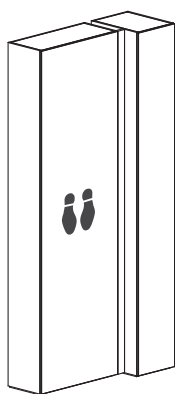

Element M

Anbaufähiges Element
Auf der rechten Seite muss
immer ein anderes Element
angebaut werden.

M

Art.-Nr.	Preis in EURO	Kolli	V.m ³	Kg
55BLIM1		4	1,1	118

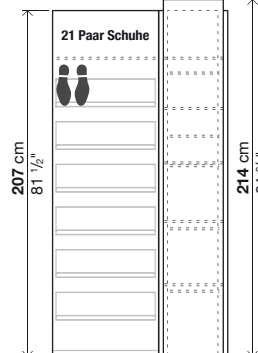
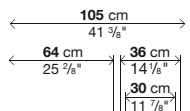
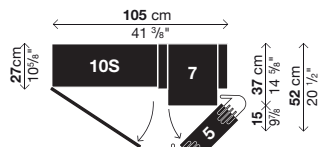
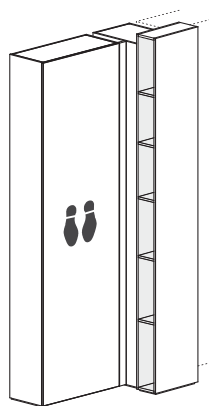

Element N

Allein stehendes oder anbaufähiges Element.

N

Art.-Nr.	Preis in EURO	Kolli	V.m ³	Kg
55BLIN1		5	0,93	102

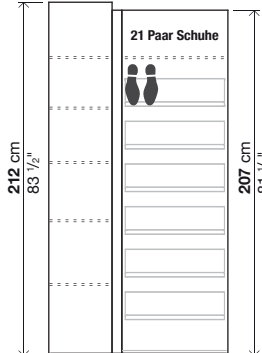
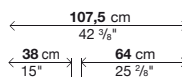
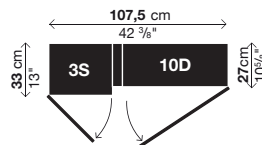
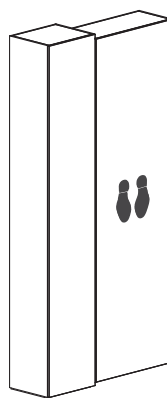

Element O

Allein stehendes oder anbaufähiges Element.

O

Art.-Nr.	Preis in EURO	Kolli	V.m ³	Kg
55BLIO1		5	0,93	94

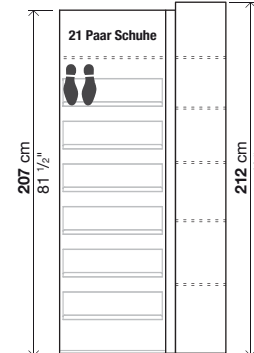
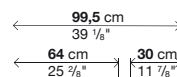
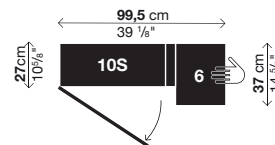
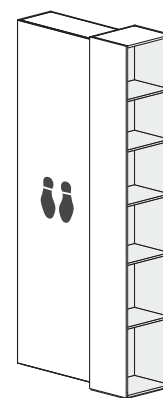

Blio Zusatzelemente

Anbaufähig

Element P

Allein stehendes oder anbaufähiges Element.

P

Art.-Nr.	Preis in EURO	Kolli V.m ³ Kg
55BLIP1		6 : 1,2 : 118

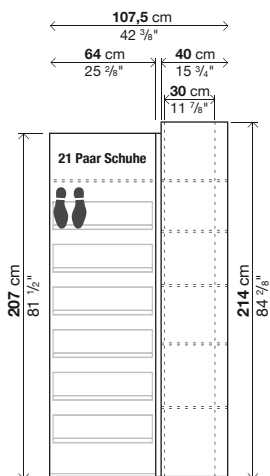
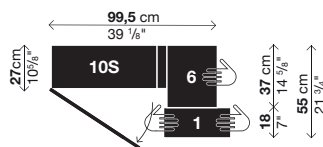
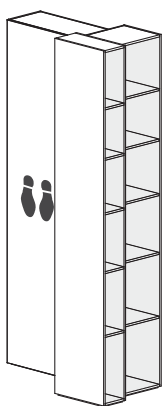

Element R

Allein stehendes oder anbaufähiges Element.

R

Art.-Nr.	Preis in EURO	Kolli V.m ³ Kg
55BLIR1		5 : 0,78 : 80

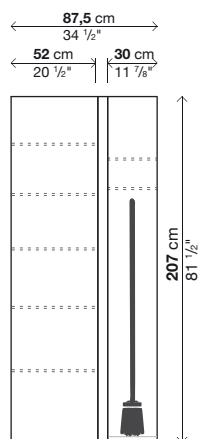
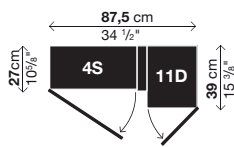
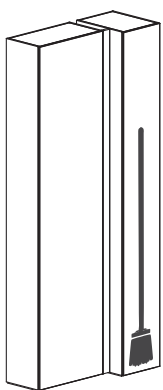

Element S

Allein stehendes oder anbaufähiges Element.

S

Art.-Nr.	Preis in EURO	Kolli V.m ³ Kg
55BLIS1		5 : 0,9 : 100

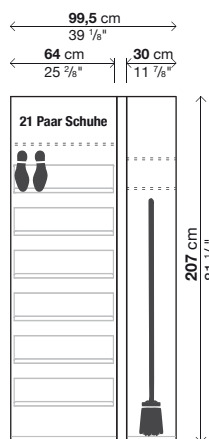
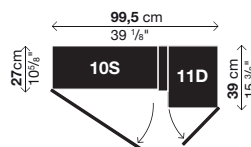
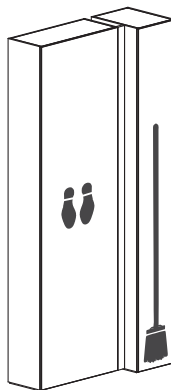

Blio

Beispiele für Zusammenstellungen

Zusammenstellung B1
Element C + Element E

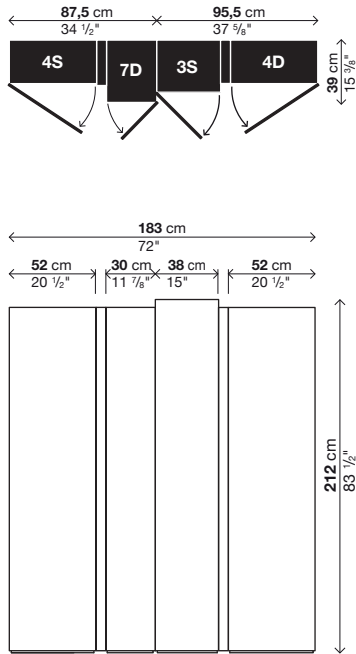

Art.-Nr.	Preis in EURO	Koff.	V. m ²	Kg
55BLIC1 + 55BLIE1	8	1,6	165	

Zusammenstellung B2
Element A + Element F

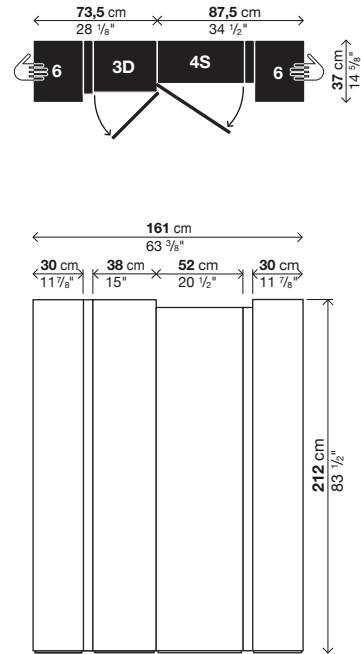

Art.-Nr.	Preis in EURO	Koff.	V. m ²	Kg
55BLIA1 + 55BLIF1	8	1,6	146	

Zusammenstellung B3
Element D + Element F

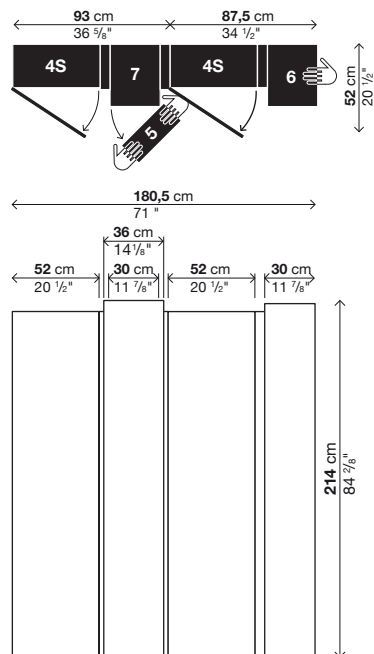

Art.-Nr.	Preis in EURO	Koff.	V. m ²	Kg
55BLID1 + 55BLIF1	7	1,8	173	

Zusammenstellung B4
Element B + Element G

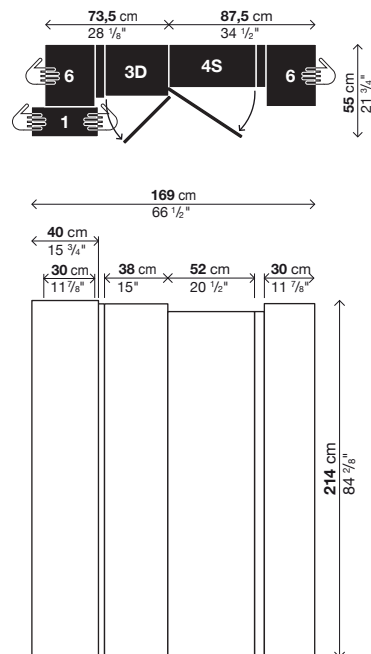

Art.-Nr.	Preis in EURO	Koff.	V. m ²	Kg
55BLIB1 + 55BLIG1	10	2,07	194	

Blio

Beispiele für Zusammenstellungen

Zusammenstellung B5
Element E + Element C + Element E

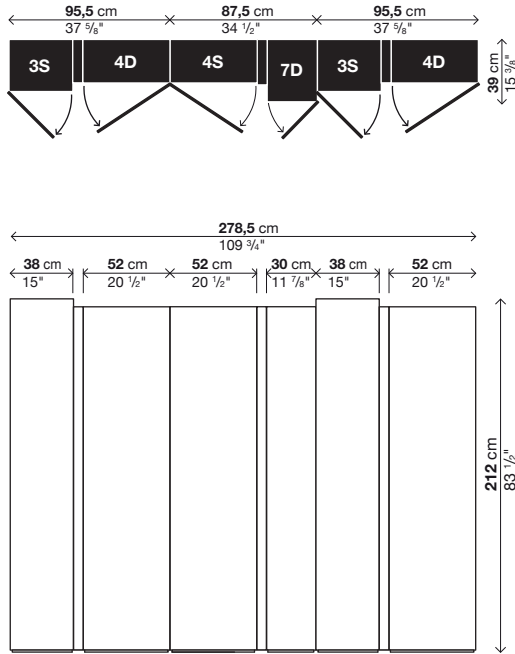

Art.-Nr.	Preis in EURO	Koll.	V. m ³	Kg
55BLIE1 + 55BLIC1 + 55BLIE1	12	2,4	250	

Zusammenstellung B6
Element A + Element C + Element F

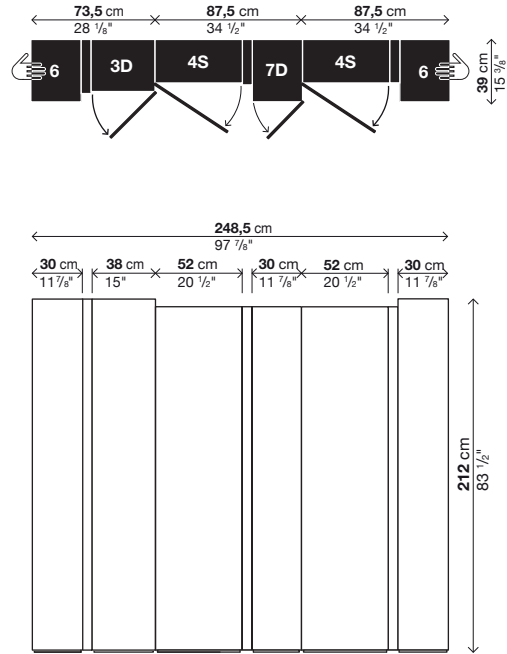

Art.-Nr.	Preis in EURO	Koll.	V. m ³	Kg
55BLIA1 + 55BLIC1 + 55BLIF1	12	2,4	230	

Zusammenstellung B7
Element C + Element D + Element F

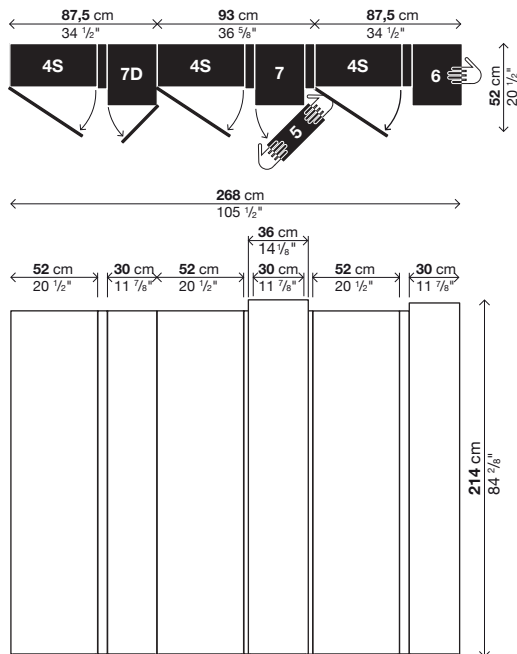

Art.-Nr.	Preis in EURO	Koll.	V. m ³	Kg
55BLIC1 + 55BLID1 + 55BLIF1	11	2,6	255	

Zusammenstellung B8
Element B + Element D + Element F

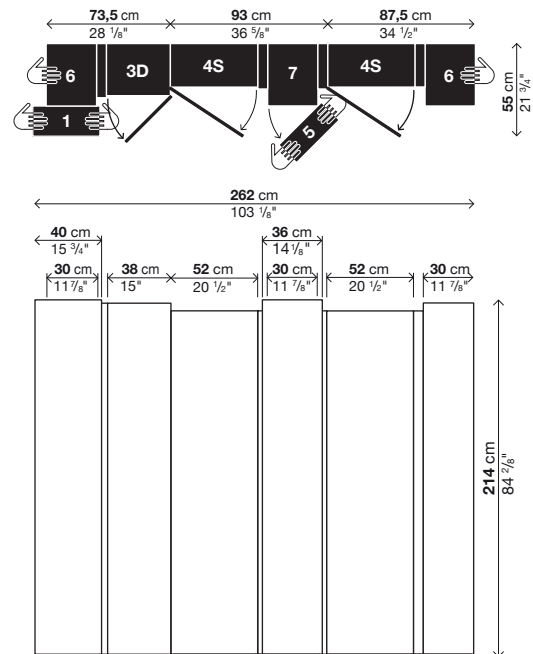

Art.-Nr.	Preis in EURO	Koll.	V. m ³	Kg
55BLIB1 + 55BLID1 + 55BLIF1	12	2,82	268	